

# sciae

44 Avenue Paul Girard  
10500 DIENVILLE  
FRANCE

www.sciae.com

# TIAGO

INDICE B - 06/09/2019

TIAGO 3619 BAHUT 3PO N°14 Réf: 19SA3030

TIAGO 3638 BAHUT 3PO N°14 Réf: 19SB3030

## NOTICE DE MONTAGE

ASSEMBLING INSTRUCTIONS

MONTAGEANLEIUNG

MANUAL DE MONTAJE

MONTAGEVOORSCHRIFT

ISTRUÇÕES DE MONTAGEM

ISTRUZIONI DI MONTAGGIO

ИНСТРУКЦИЯ ПО СБОРКЕ

Naputci za montažu

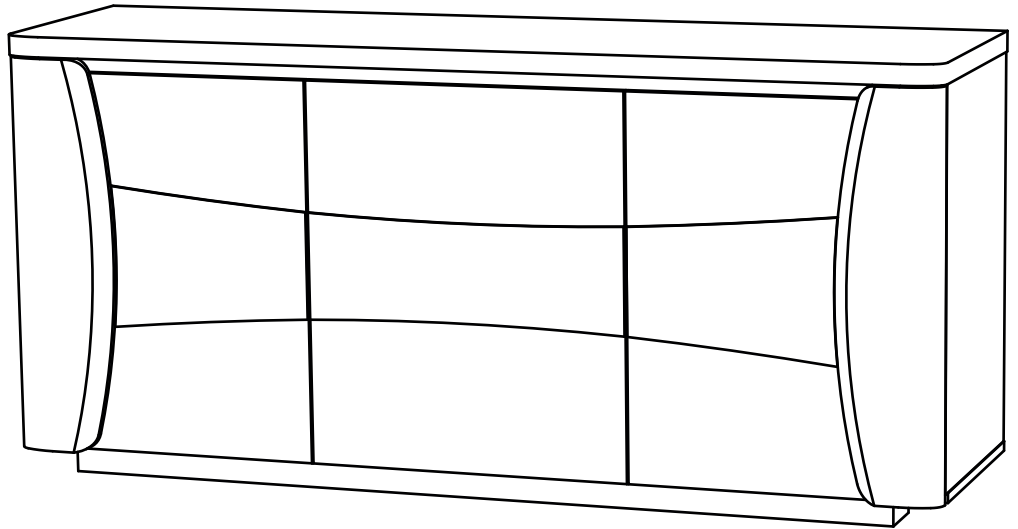

2H30

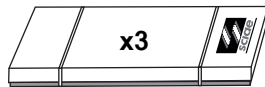

x3



Package 1: 30 Kg

Package 2: 30 Kg

Package 3: 32 Kg

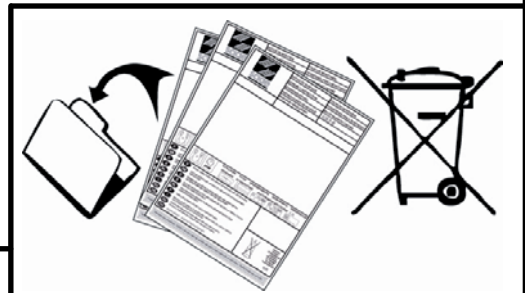

**F** POUR L'APRES-VENTE, RETOURNEZ AU MAGASIN AVEC CETTE NOTICE

**GB** FOR THE AFTER SALES, GO BACK TO THE SHOP WITH THIS ASSEMBLY INSTRUCTION

**D** WENDEN SIE SICH BITTE AN IHREN HANDLER UND GEBEN SIE IHM DIE KENNUMMER DES MOBELS UND DIE TEILNUMMER

**E** EN CASO DE SERVICIO POST-VENTA DEBEN DE VOLVER A LA TIENDA CON LAS INSTRUCCIONES DE MONTAJE

**NL** VOOR SERVICE NA VERKOOP, GA NAAR UW LEVERANCIER MET DEZE MONTAGE HANDLEIDING

**P** PARA O POS VENDA, VOLTE A LOJA COM ESTA FOLHA

**I** SERVIZIO POST VENDITA: E NECESSARIO PRESENTARSI SUL PUNTO VENDITA CON QUESTE ISTRUZIONI DI MONTAGGIO

**RU** ДЛЯ ПОСЛЕПРОДАЖНОГО ОБСЛУЖИВАНИЯ ПРОСЬБА ОБРАТИТЬСЯ В МАГАЗИН ПРЕДЪЯВИВ НАСТОЯЩУЮ ИНСТРУКЦИЮ ПО СБОРКЕ

**HR** U SLUČAJU REKLAMACIJE, VRATITE SE NA PRODAJNO MJESTO S OVIM UPUTAMA ZA MONTAŽU

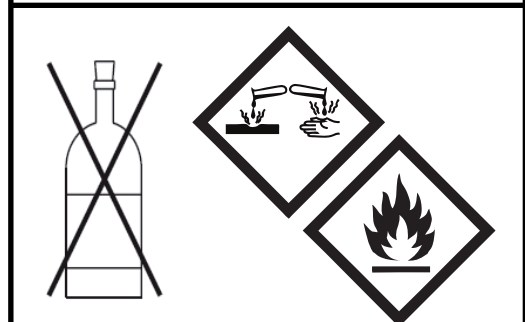
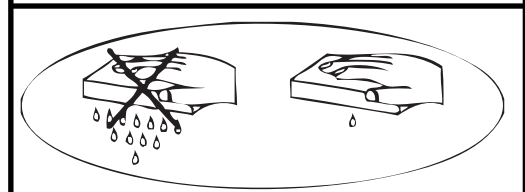







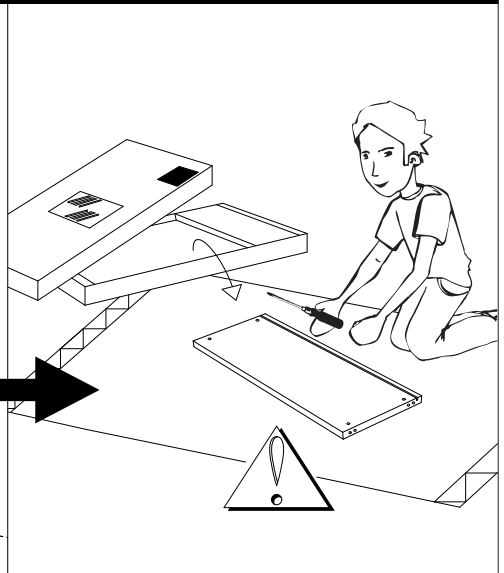
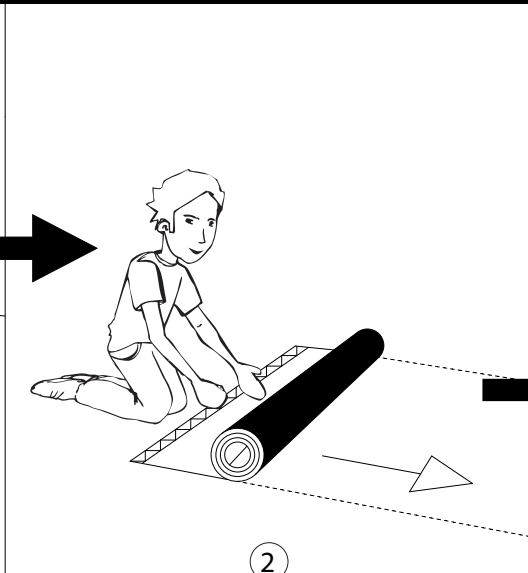
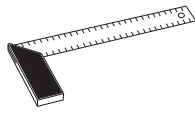
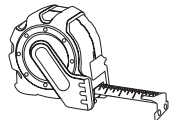
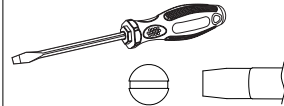
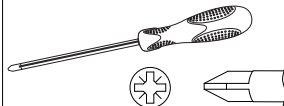
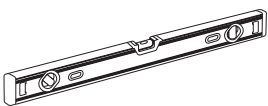
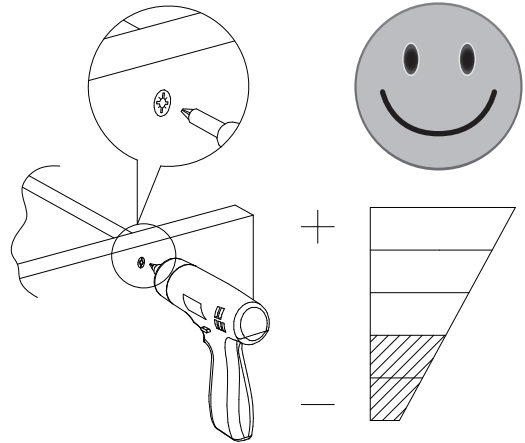
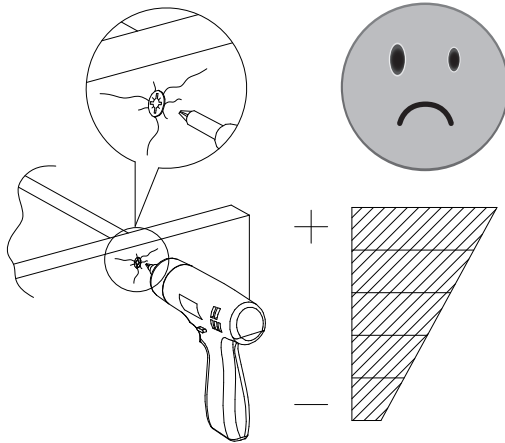
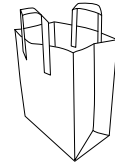
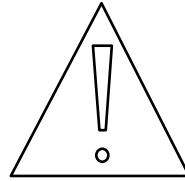

SCIAE se réserve le droit de modifier sans préavis tout ou partie de ses collections - Meuble vendu sans accessoire

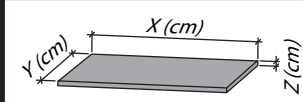
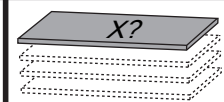
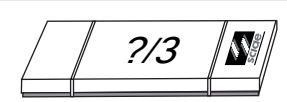

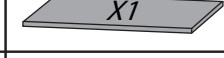
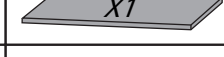
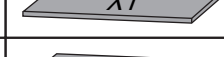
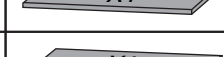
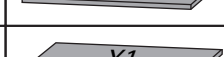
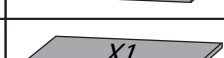
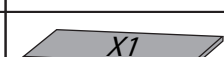
	+40°C +104°F	
	+15°C +59°F	



1 an  
1 year

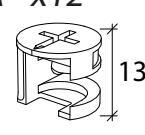
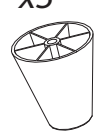
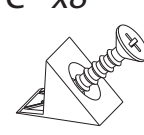

OK

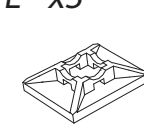
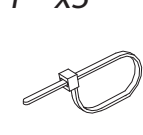
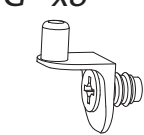

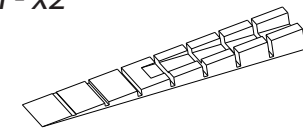
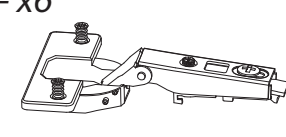
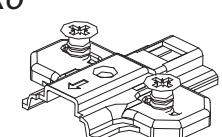
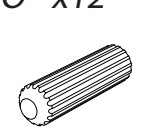



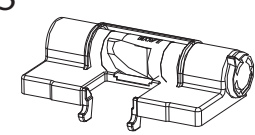

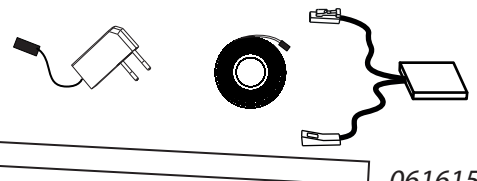
DESIGNATION		N°		
Dessous	180 x 44,2 x 1,8	1		2
Côté gauche	73,4 x 45,8 x 1,6	2		2
Séparation	68,3 x 41,6 x 1,6	3		1
Intermédiaire	176,6 x 11 x 1,6	4		3
Derrière pliant	177,5 x 74,4 x 0,25	6		3
Côté droit	73,4 x 45,8 x 1,6	7		2
Dessus	180,2 x 50 x 3,8	8		3
Tablette gauche	57,5 x 41,4 x 2,5	9		2
Porte gauche	72 x 53,5 x 1,6	Z1		1
Porte droite	72 x 53,5 x 1,6	Z2		1
Porte centrale	72 x 61,4 x 1,6	Z3		1
Face de socle	160 x 11 x 5	17		3
Tablette droite	117,3 x 41,4 x 2,5	19		2
Montant de porte	74,9 x 20 x 4	30		1

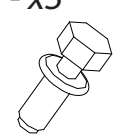
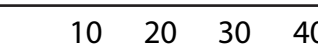
<b>A - x12</b>  061119	<b>B - x3</b>  061240	<b>C - x8</b>  061074	<b>D - x23</b>  060642	<b>E - x3</b>  063500	<b>F - x3</b>  063501	<b>G - x8</b>  061243
---	--	--	---	---	--	--

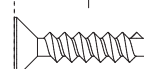
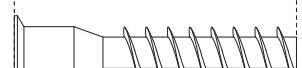
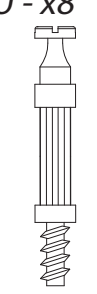
<b>H - x2</b>  061415	<b>M - x6</b>  060001	<b>N - x6</b>  060983	<b>O - x12</b>  081500
--	--	--	---

<b>P - x3</b>  060018	<b>S - x1</b>  060690	<b>T - x1</b>  061615
--	--	--

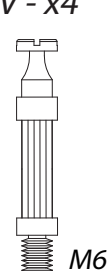
<b>Y - x3</b>  060740	  VBA TF 4X20  VIS AUTO 7X38  W- x2 062003  X- x13 062175	<b>U - x8</b>  061120	  	<b>V - x4</b>  M6 060945
--	--	--	---	--



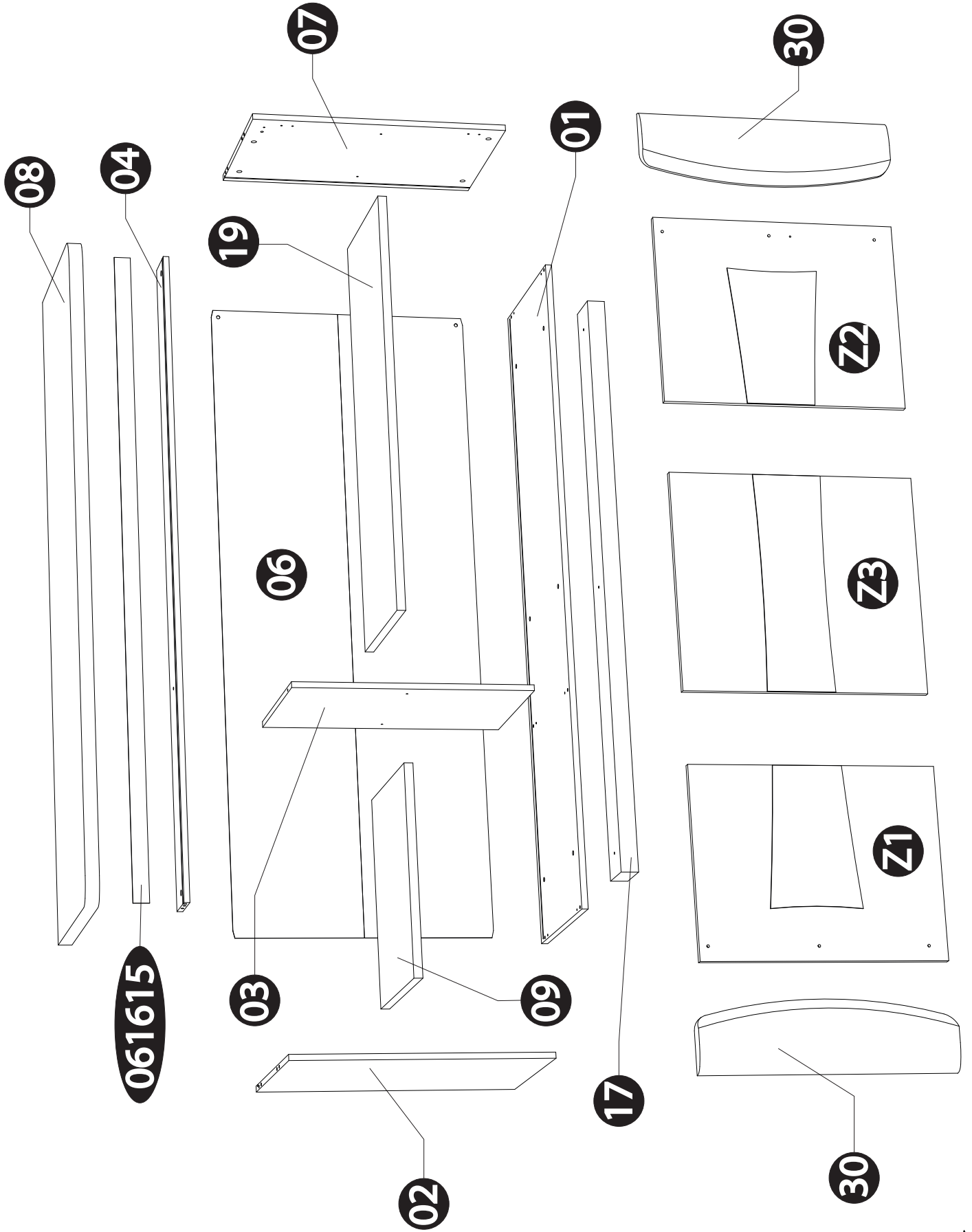

1

Y-x3

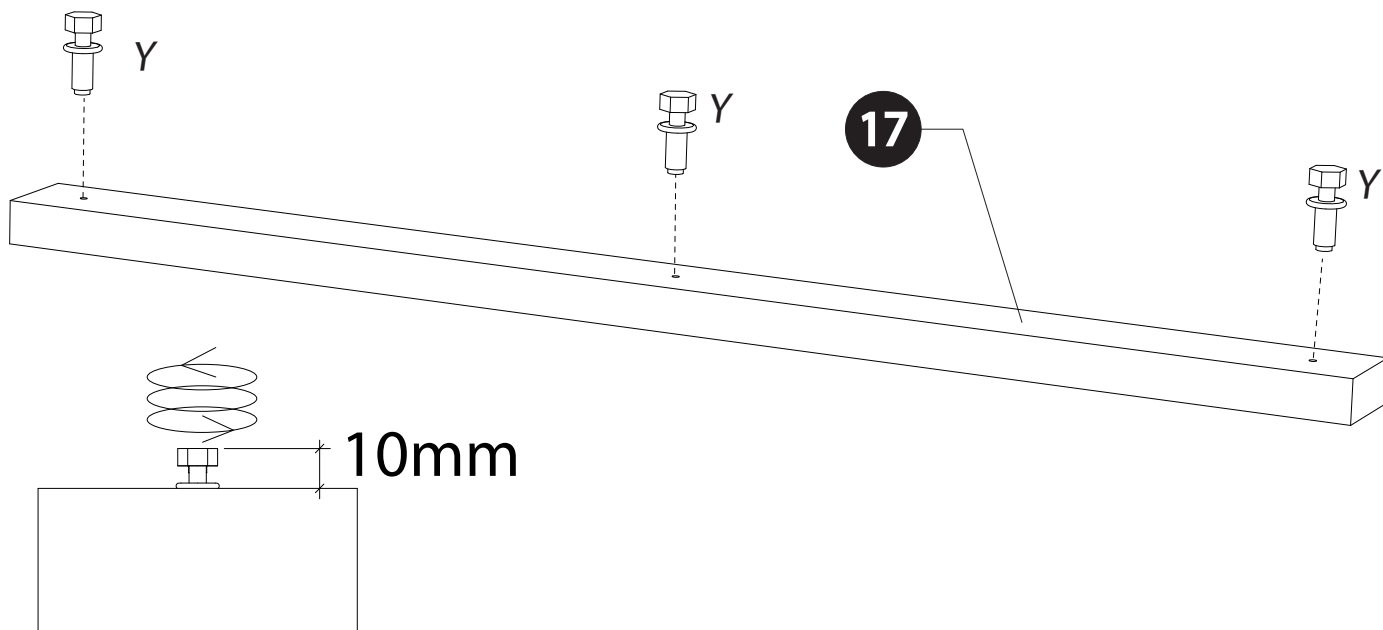

2

B-x3



X-x6

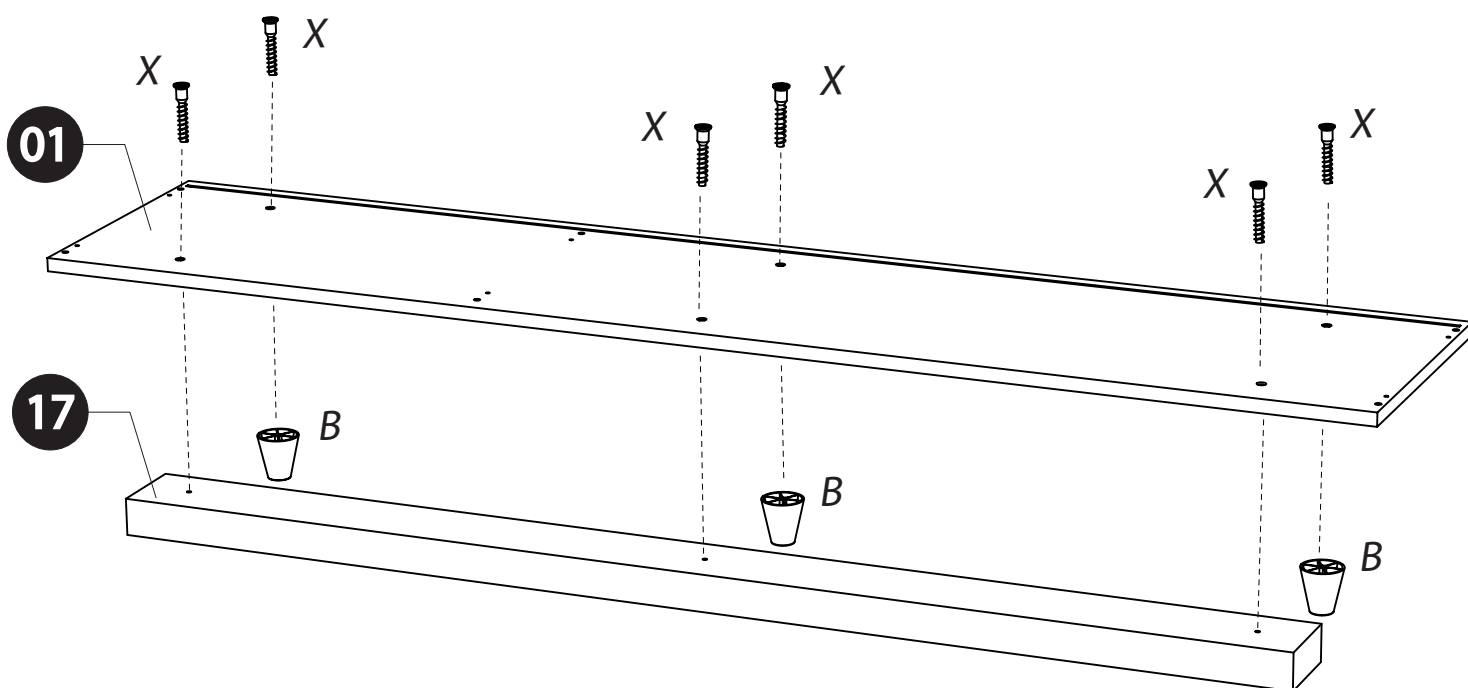
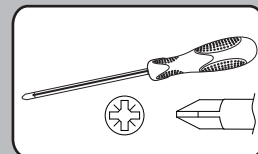
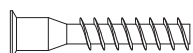

3

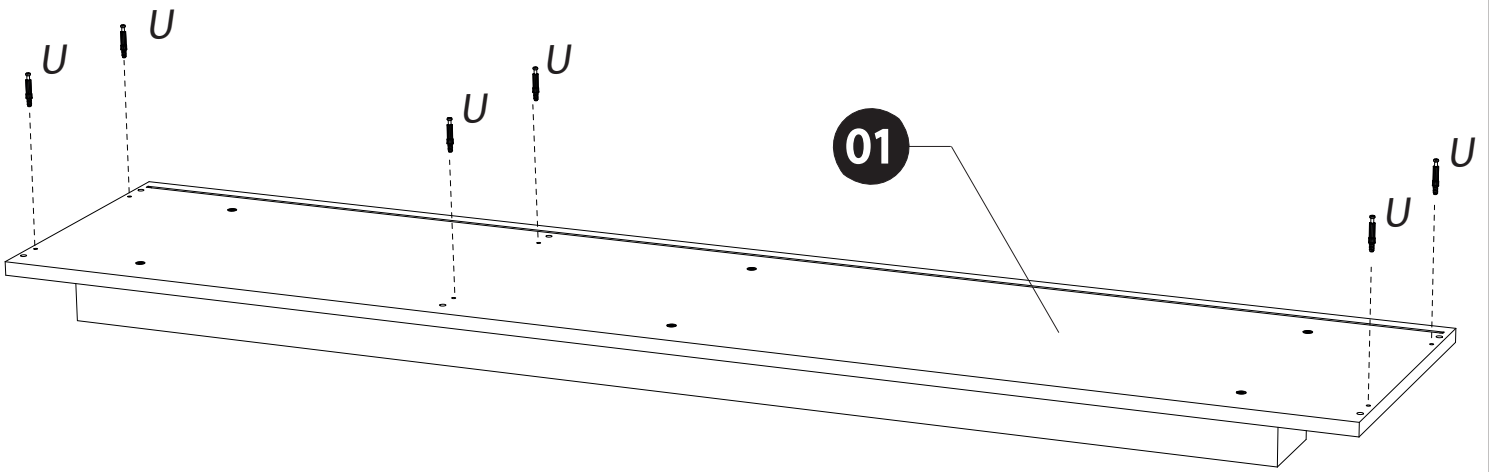
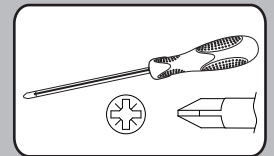
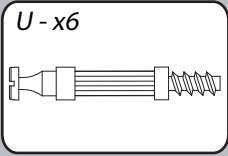

4

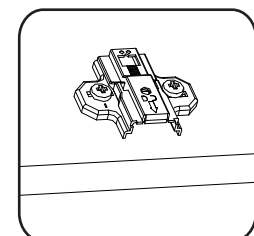
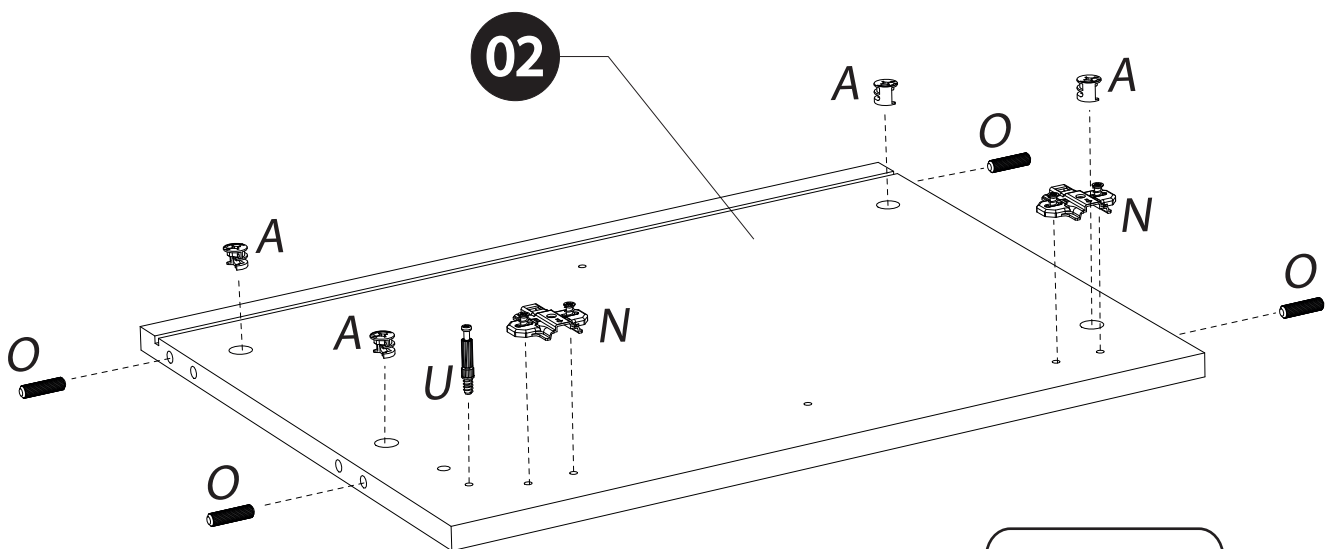
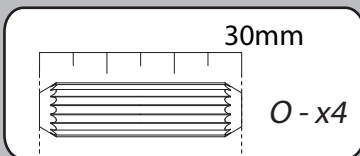
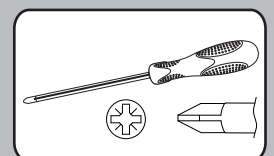
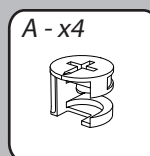
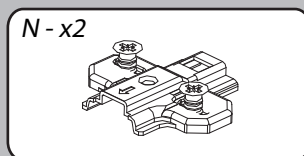
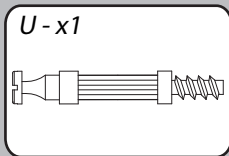

5

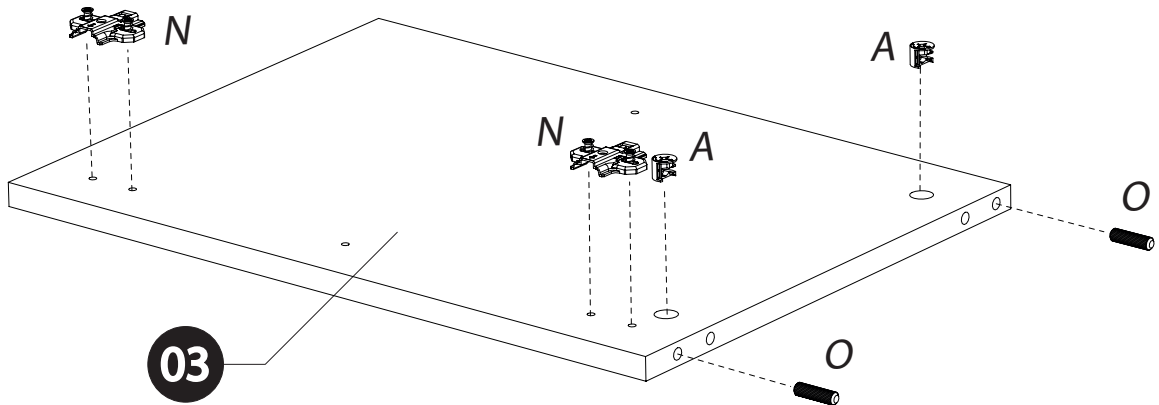
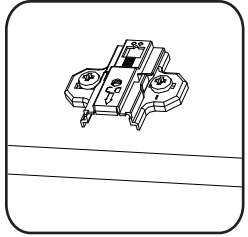
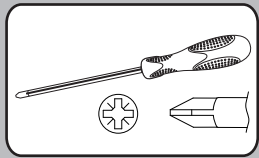
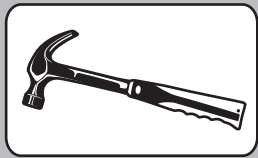
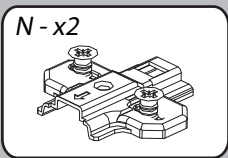
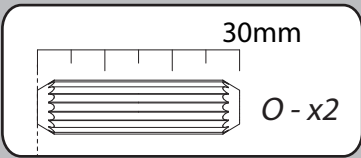
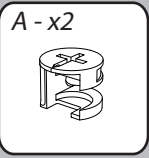

6

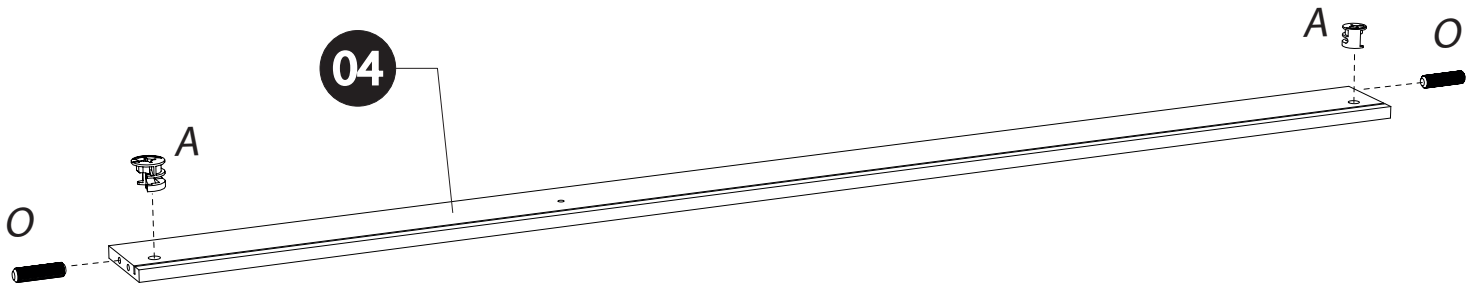
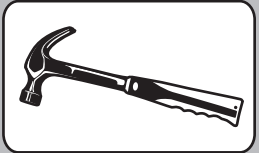
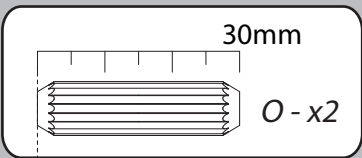
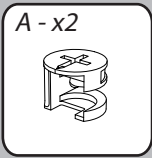

7

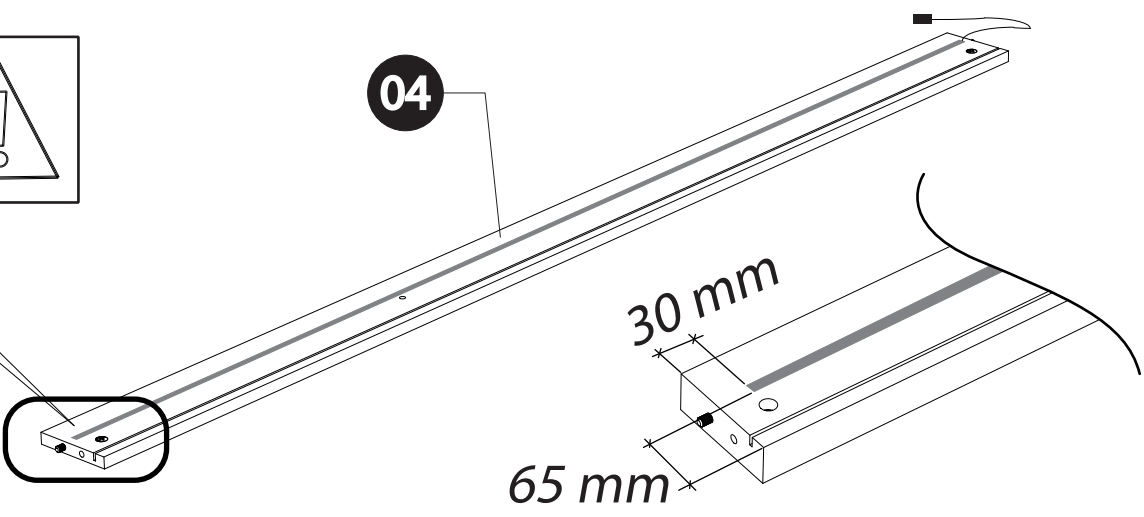
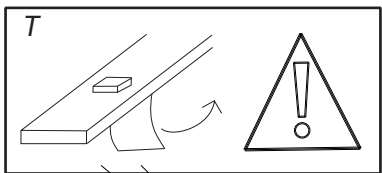
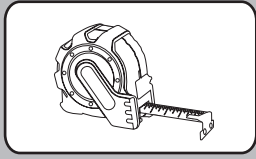
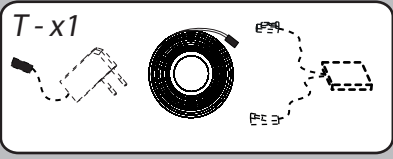

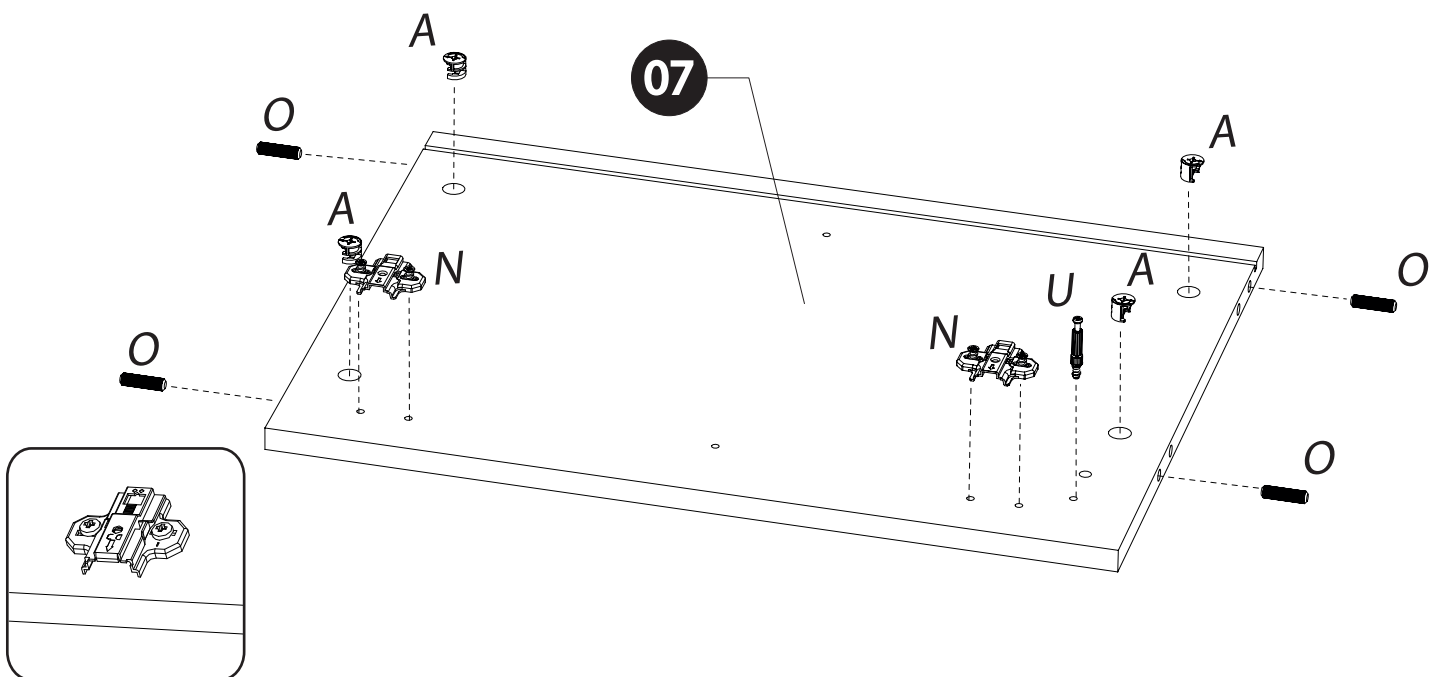
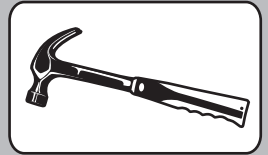
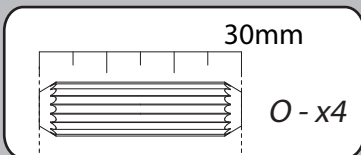
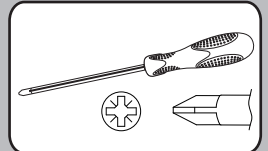
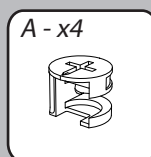
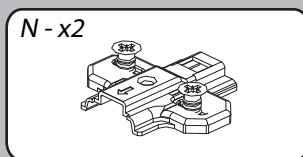
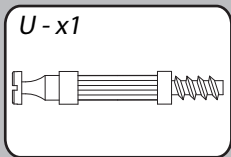
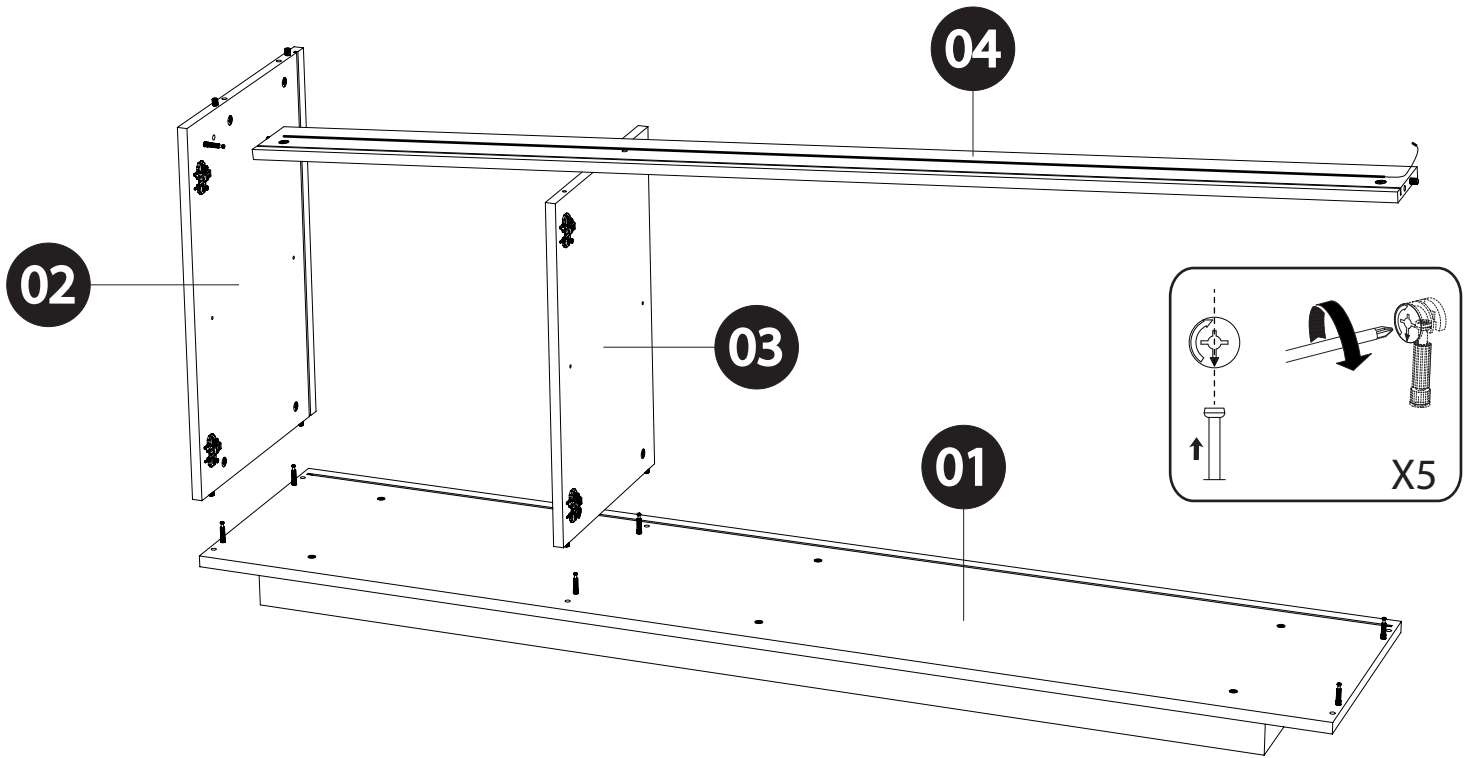
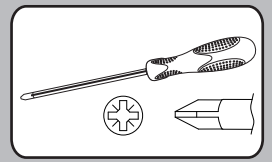



# 10

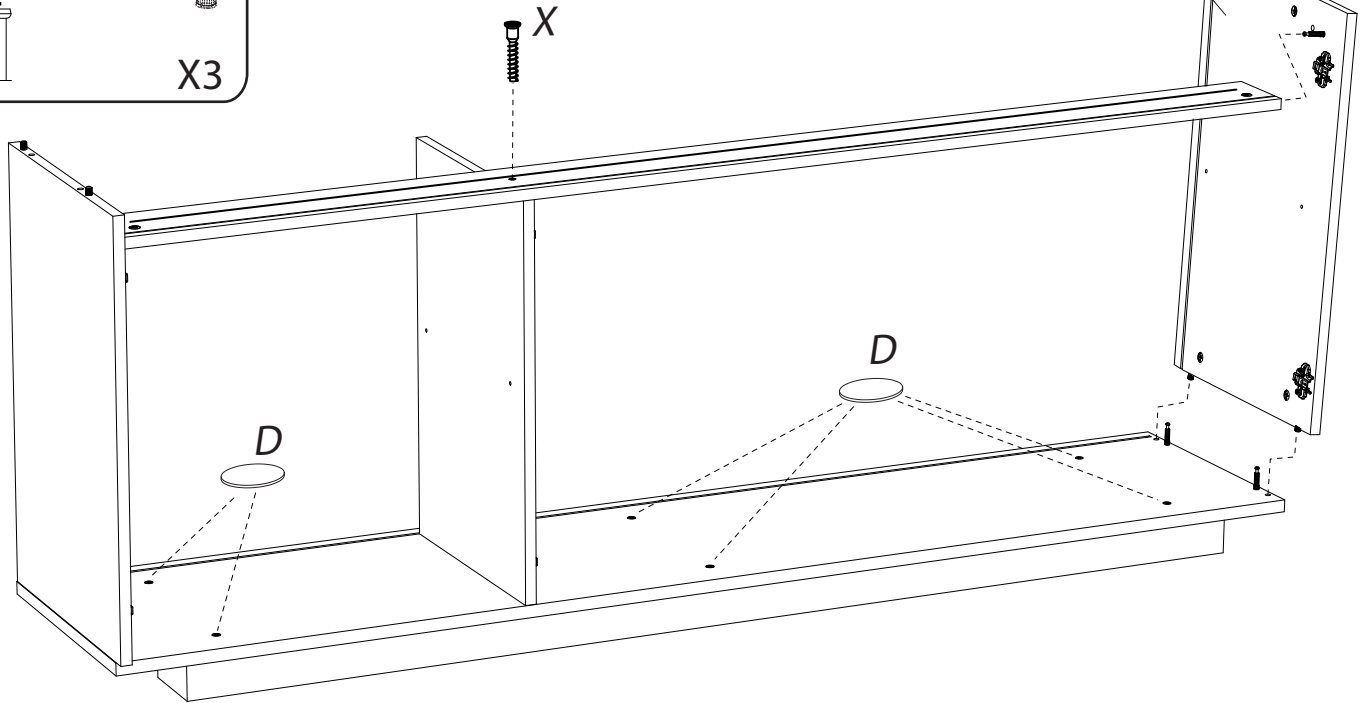
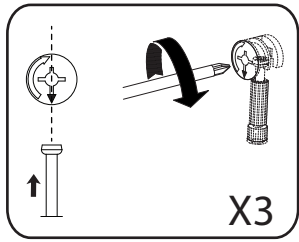
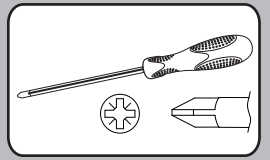
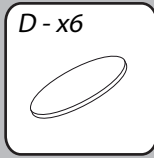
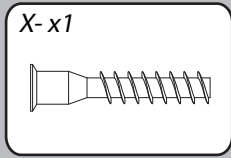

# 11

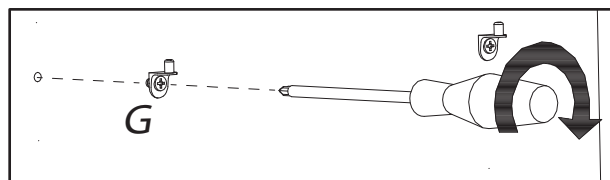
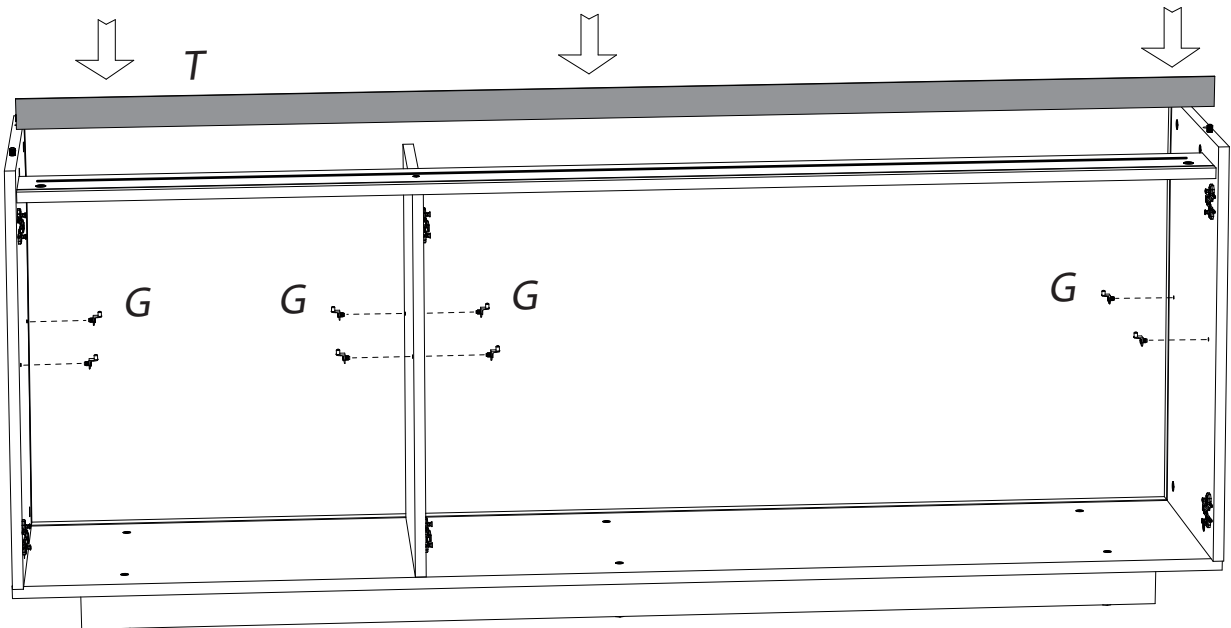
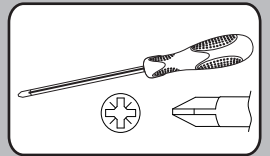
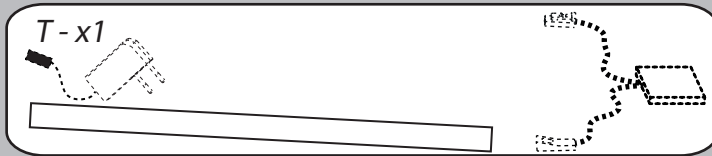
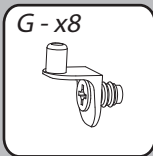

# 12

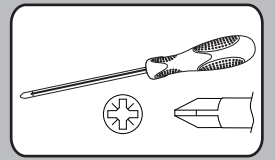
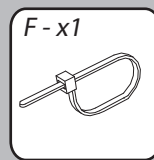
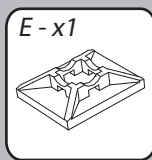
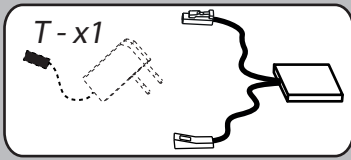

06



09

19

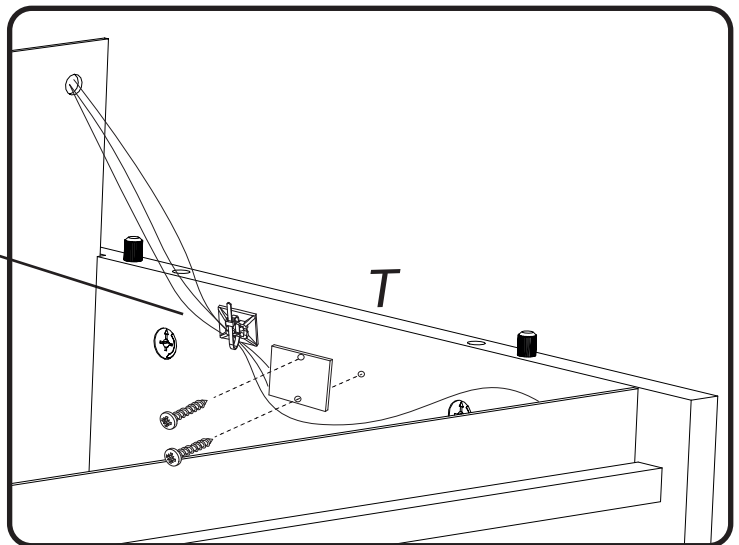
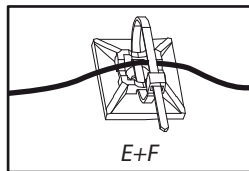
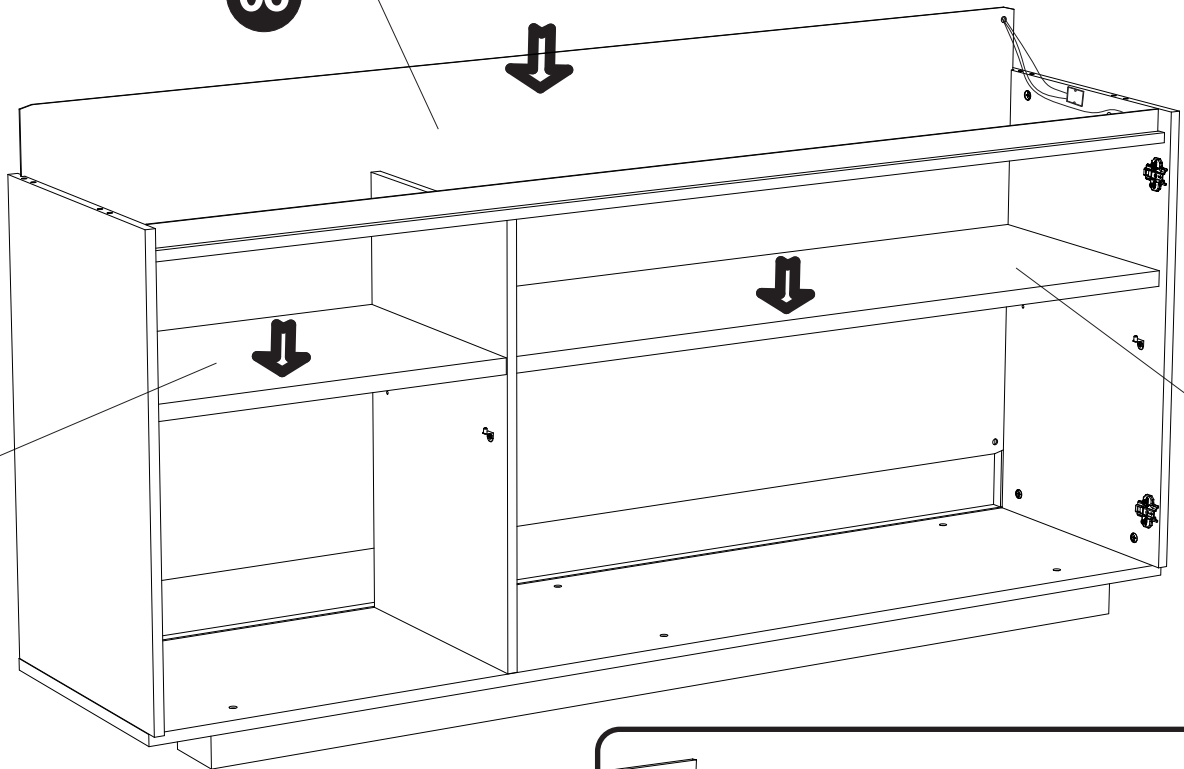

# 13

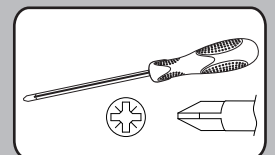
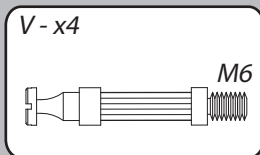

08

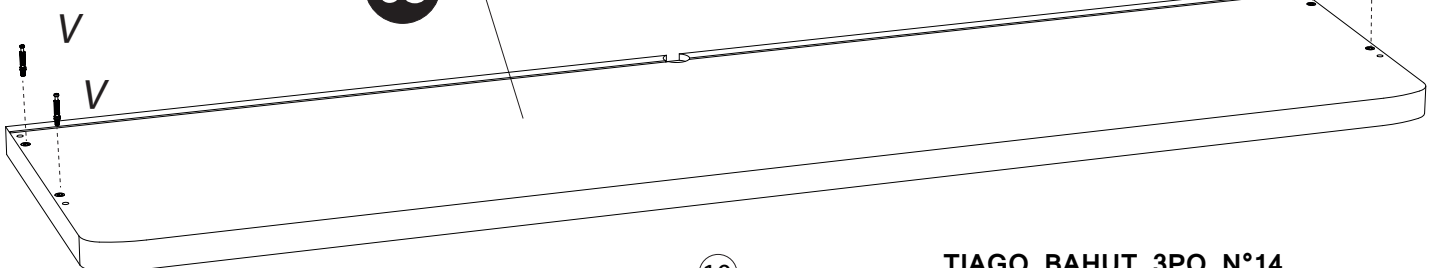
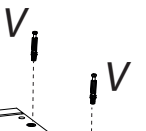
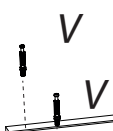

10

TIAGO BAHUT 3PO N°14

# 14

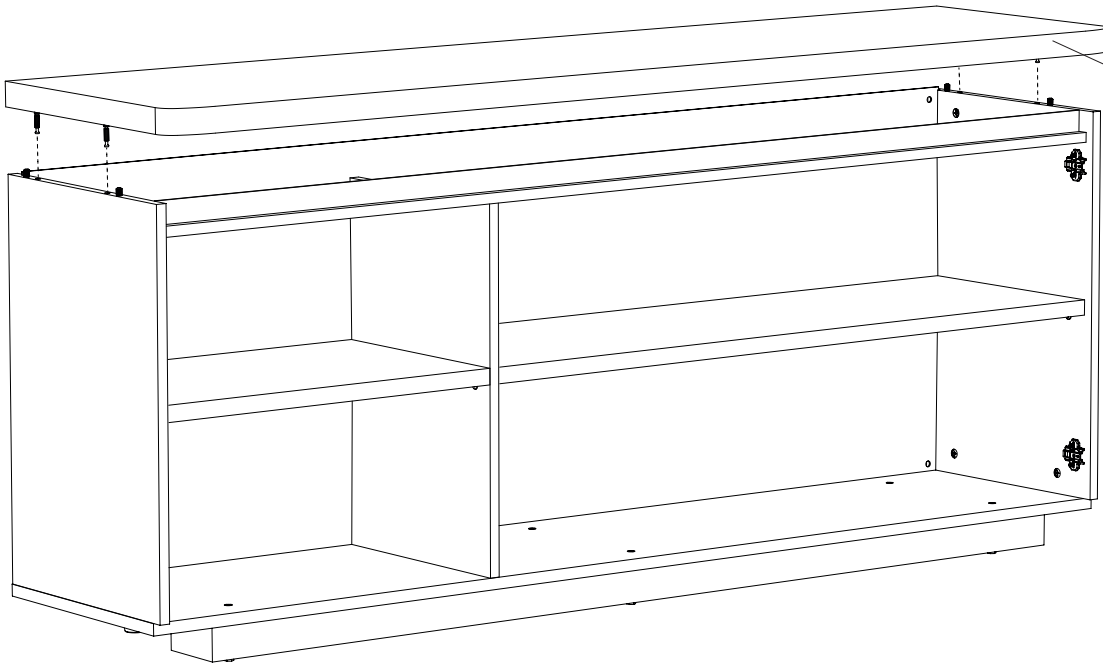
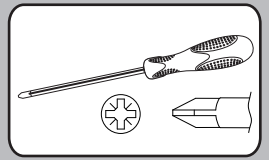

08

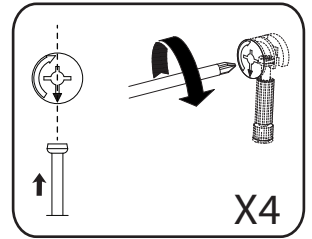

X4

# 15

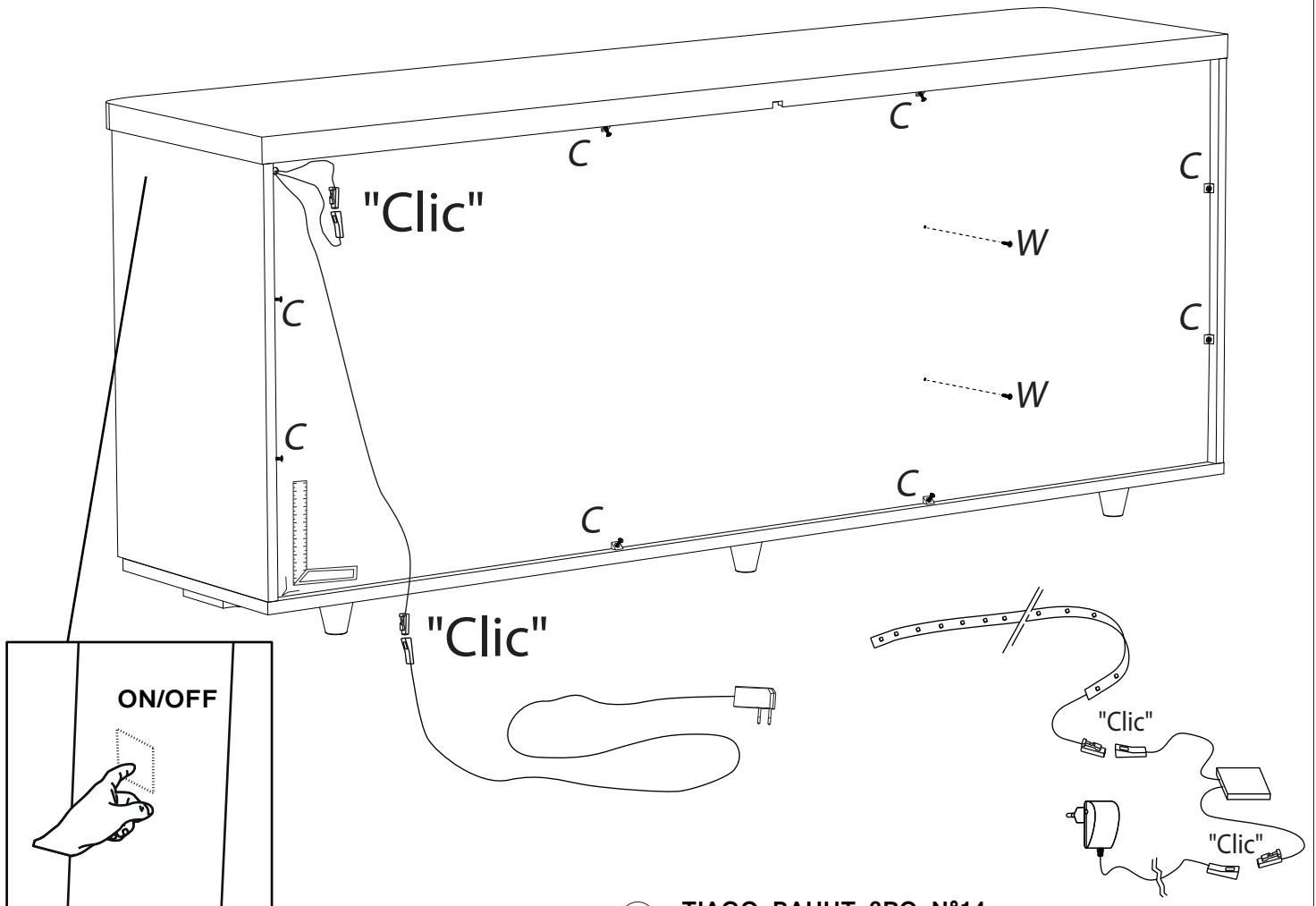
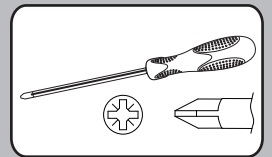
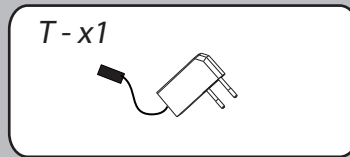
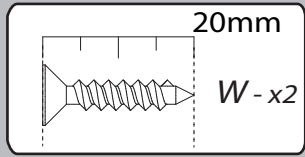
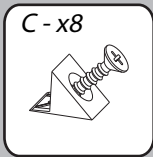

11 TIAGO BAHUT 3PO N°14

# 16

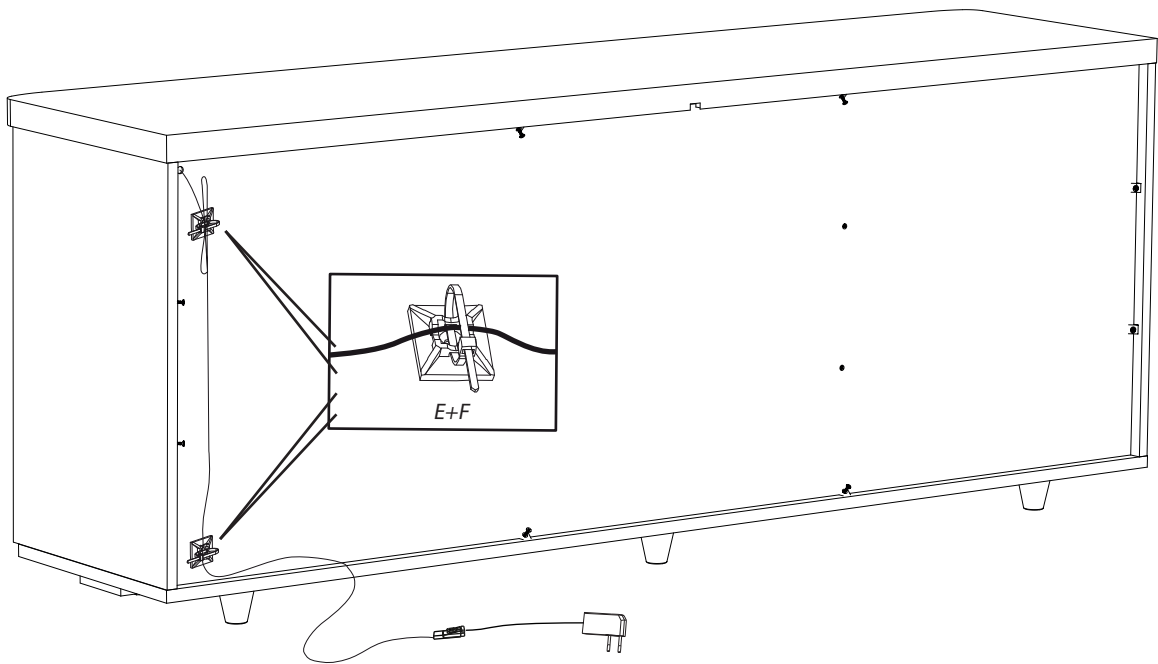
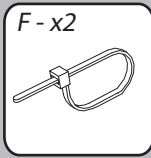
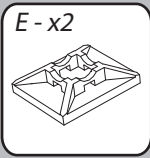

# 17

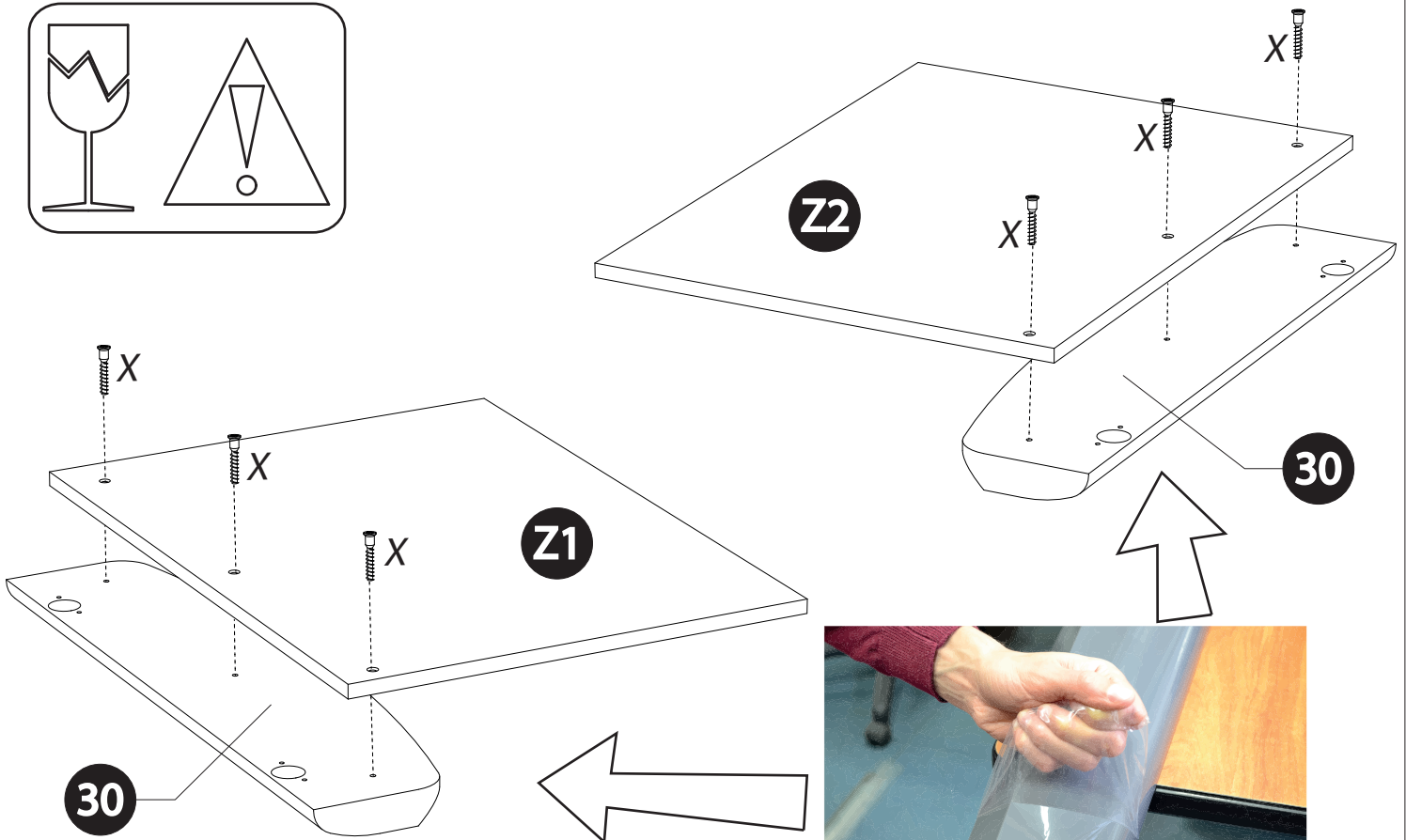
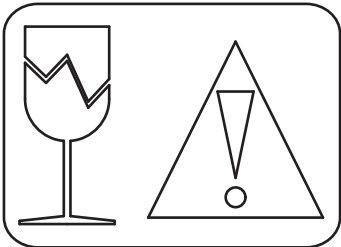
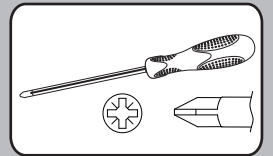
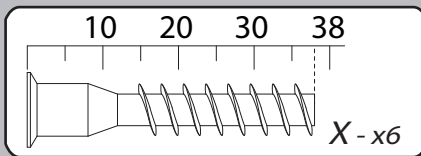

# 18

M - x4

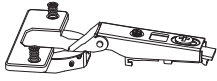

P - x2

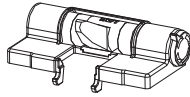

D - x6

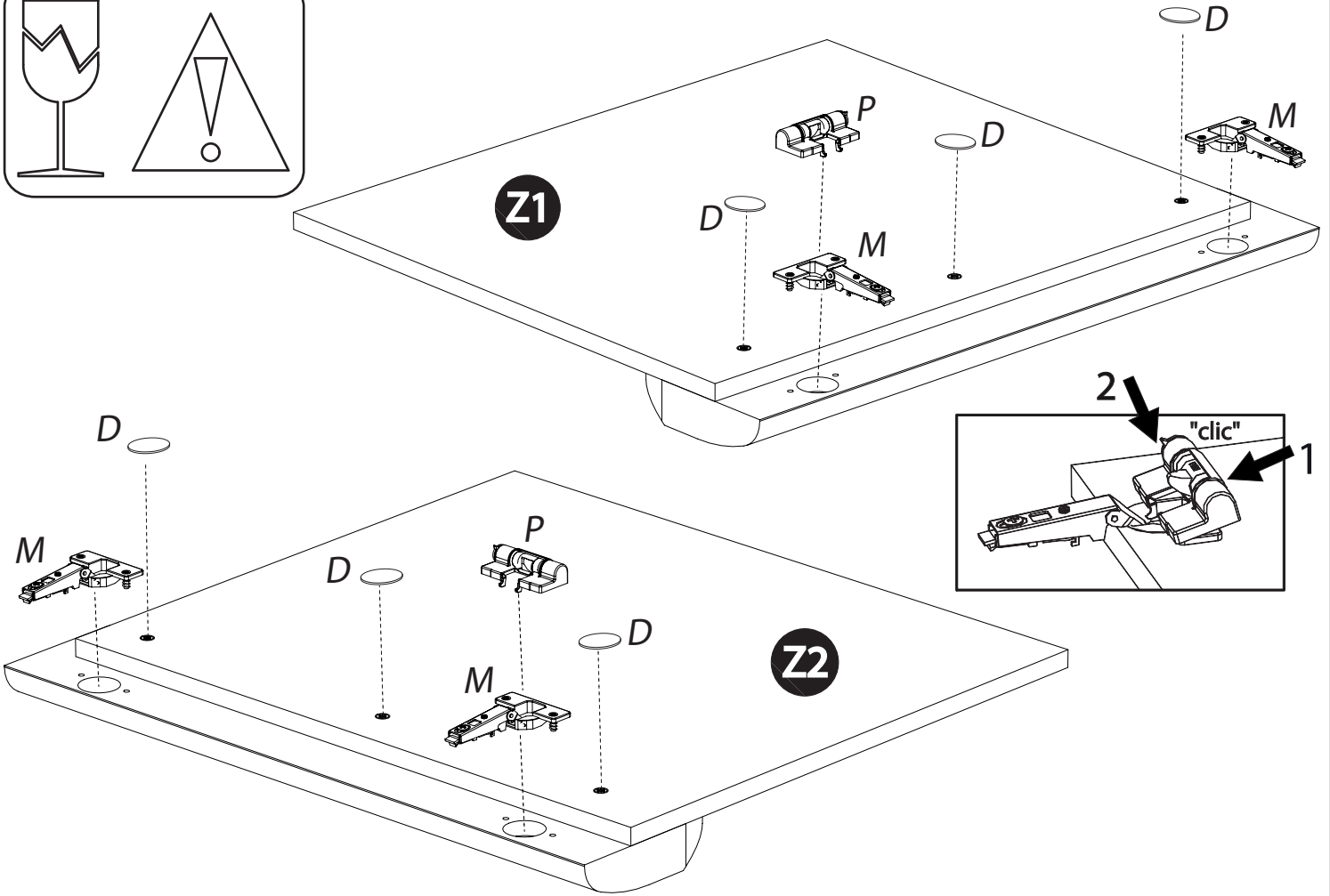
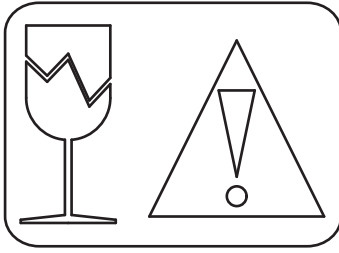
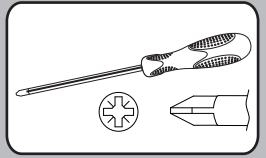

# 19

M - x2

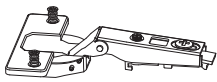

P - x1

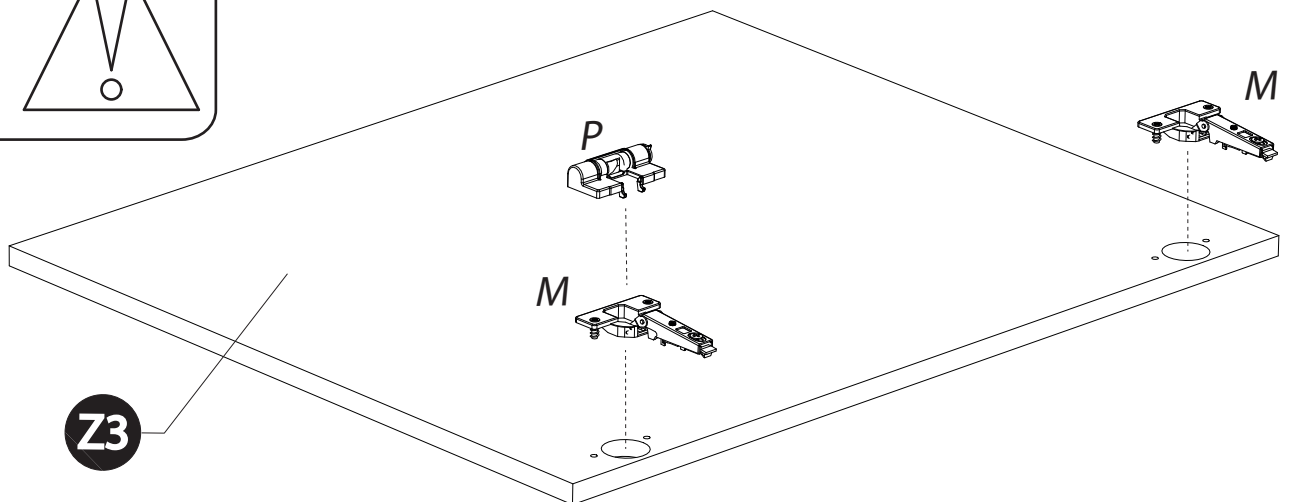
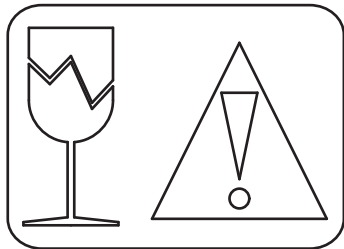
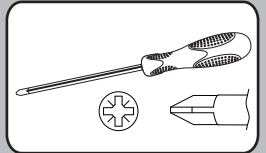
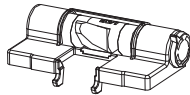

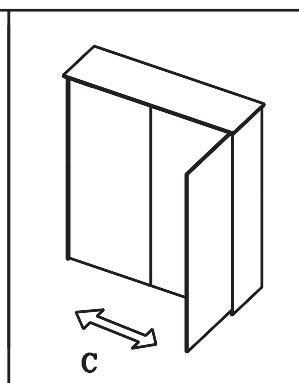
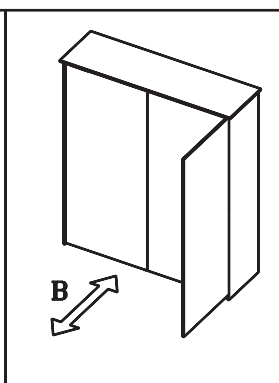
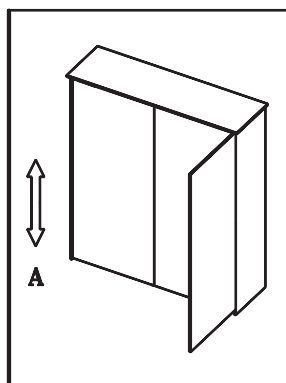
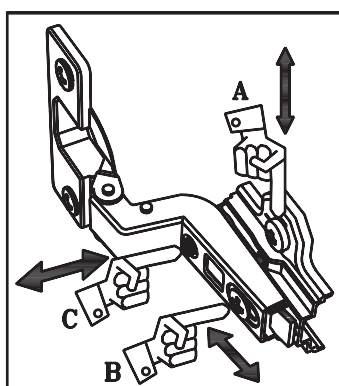
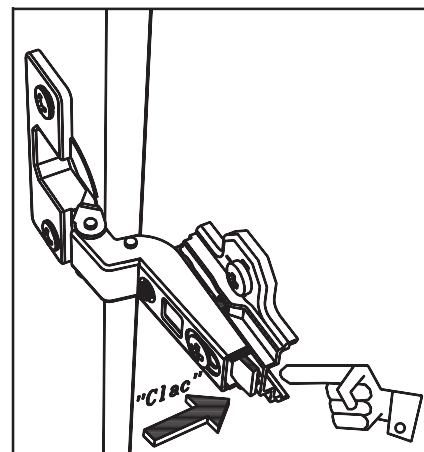
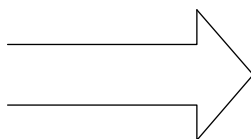
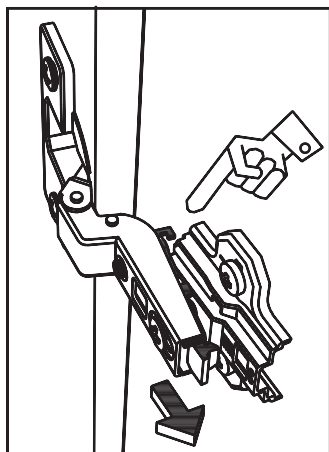
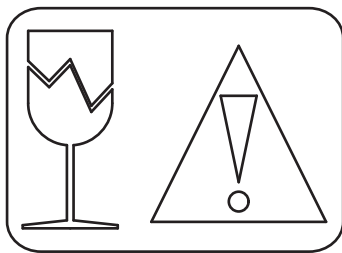
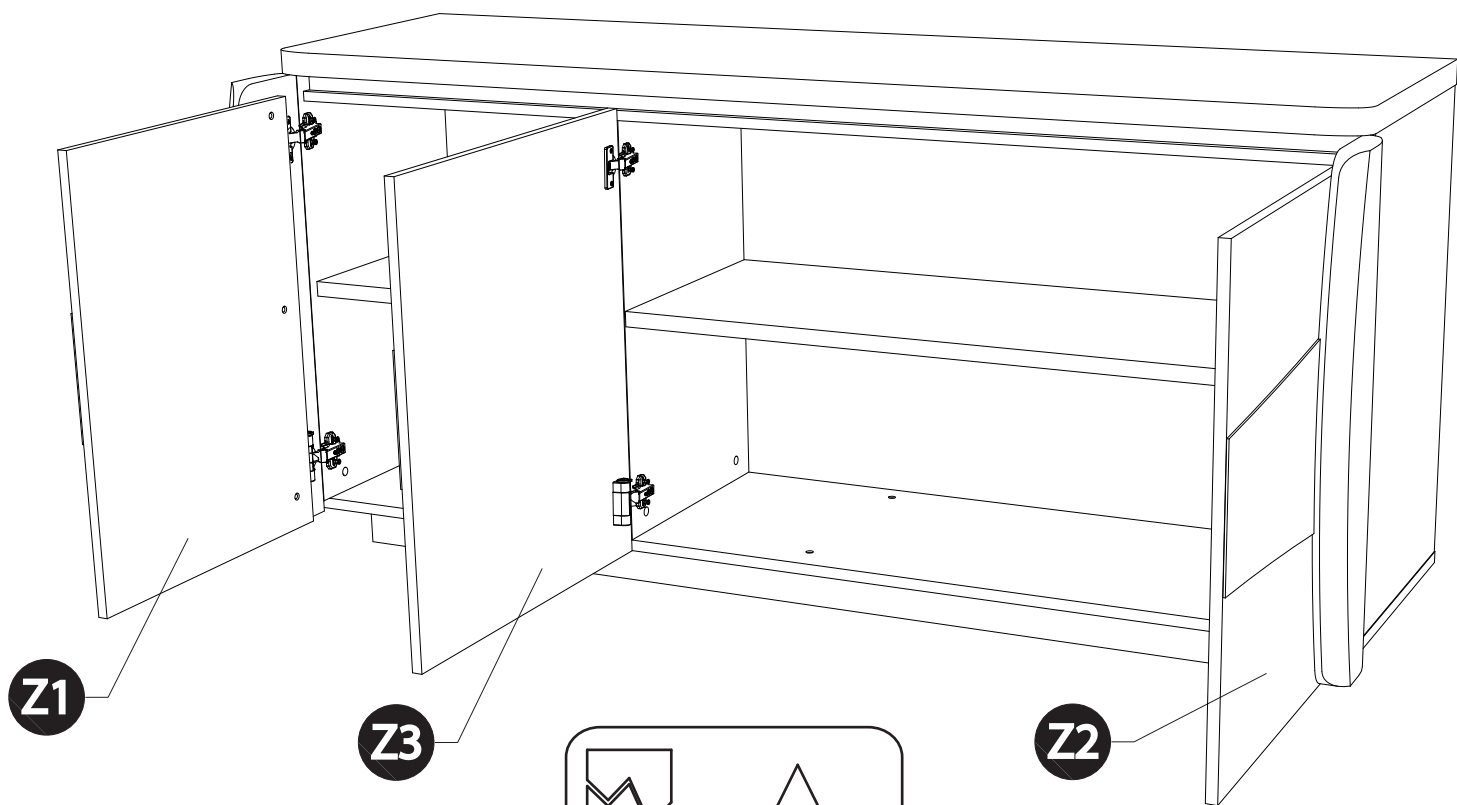

S - x1

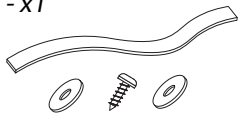

D - x11

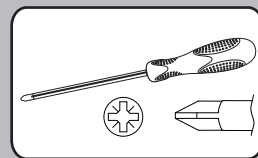

FRANCAIS: Pour votre sécurité il est impératif de fixer votre meuble au mur.

ENGLISH: For your own safety, this furniture must be fastened to the wall imperatively.

DEUTSCH: Zu Ihre Sicherheit, ist es notwendig Ihr Möbel auf dem Wand zu fixieren.

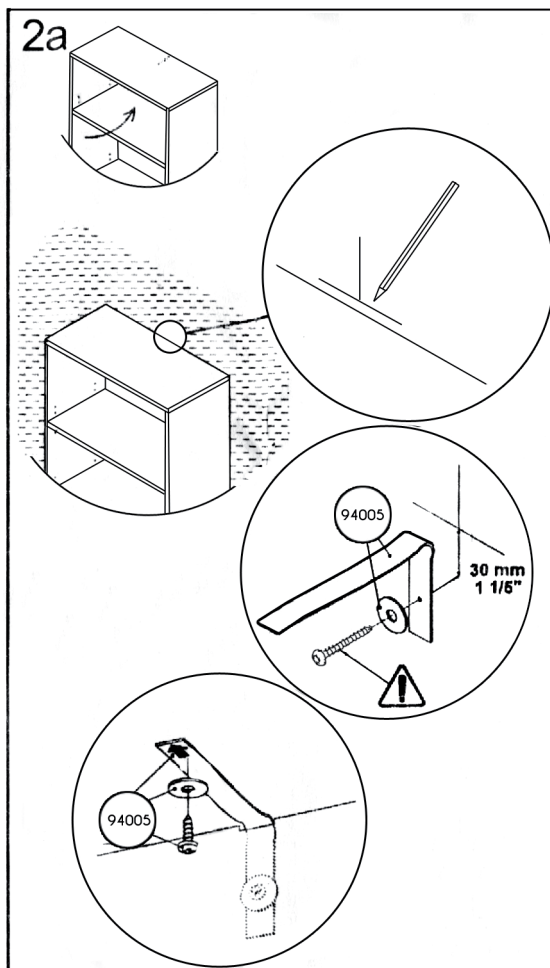

FRANCAIS

IMPORTANT: La vis fournie avec le dispositif anti-bascule est destinée à fixer le dispositif dans le meuble. Pour la fixation au mur, compléter par une vis adaptée au support mural. En cas de doute, contacter un magasin de bricolage.

ENGLISH

IMPORTANT: The screw supplied together with the anti-topple bracket is to be used only for fixing the anti-topple bracket to the furniture. In addition to this, you will need to choose a screw or fitting which is suitable for securing the bracket to the kind of walls you have. If you are unsure about what type of screw to use contact your local hardware store.

DEUTSCH

WICHTIG: Die dem kippschutz beigefügten schrauben sind ausschließlich für die befestigung des kippschutzes am möbelstück vorgesehen. Für die befestigung des kippschutzes an der wand benötigen sie zusätzlich schrauben oder beschläge, die zur beschaffenheit der wand passen. Falls sie nicht sicher sind, welche art von schrauben geeignet sind, wenden sie sich bitte an den fachhandel.

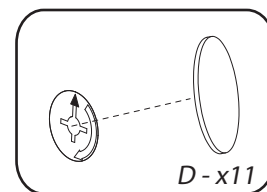
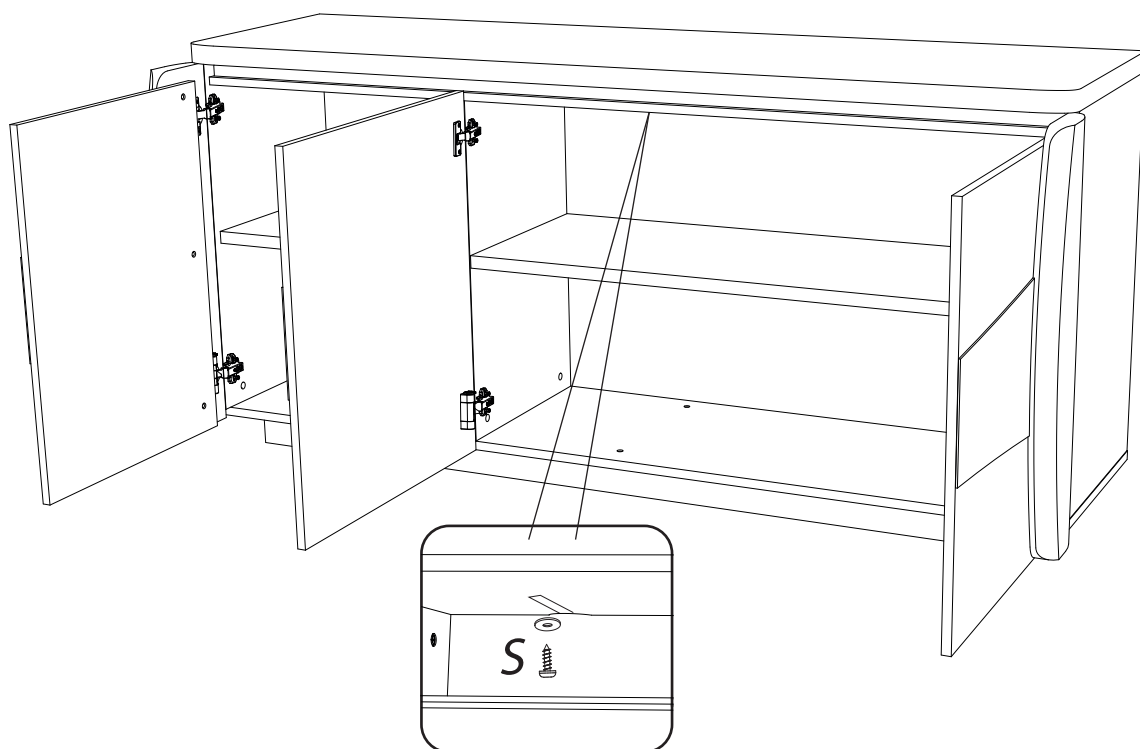

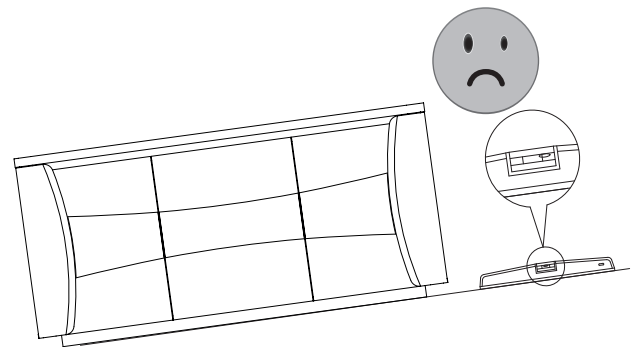
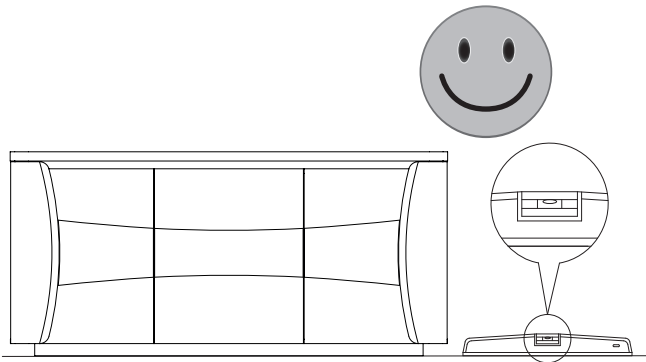
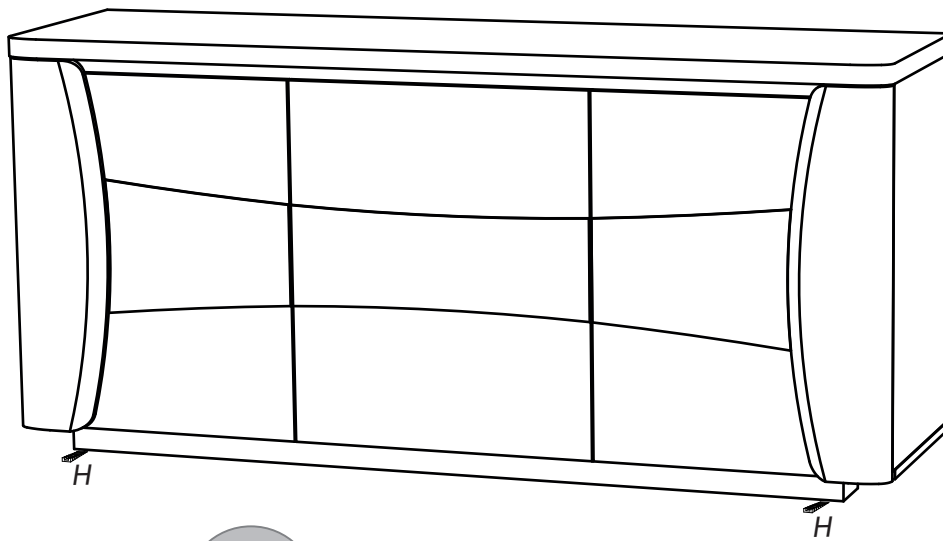
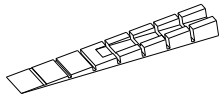
**TIAGO 3619:**

Bahut 3po composé de panneaux de particules revêtus papier noir laqués anthracite brillant et revêtus papier blanc laqués blanc brillant.

L.180 cm - H.85 cm - P.50 cm.

A monter soi-même.

**TIAGO 3638:**

Bahut 3po composé de panneaux de particules revêtus papier noir laqués noir brillant et revêtus papier blanc laqués blanc brillant.

L.180 cm - H.85 cm - P.50 cm.

A monter soi-même.

**FRANCAIS - Recommandations de démontage :**

En cas de déménagement, il convient de procéder au démontage de votre meuble, en ôtant toute la visserie.

**ENGLISH - Disassembly advices:**

In case of moving, it is needed to dismantle the furniture removing the fittings.

**DEUTSCH - Empfehlungen für die Demontage:**

Bei Transport bitte alle Beschläge demontieren.

"Les meubles contenant des panneaux à base de bois (panneaux de particules, panneaux de fibres, contreplaqué...) peuvent émettre des substances polluantes dans l'air intérieur. Il est ainsi recommandé, après l'installation du meuble dans son logement, d'aérer fréquemment la pièce concernée pendant au moins quatre semaines afin de réduire son exposition aux polluants émis par le meuble."