

INDICE A - 12/03/2019

PRADO 3615 ARMOIRE 3PO 1G N°33 Réf: 18CC5310

PRADO 4381 ARMOIRE 3PO 1G N°33 Réf: 18CD5310

## NOTICE DE MONTAGE

ASSEMBLING INSTRUCTIONS

MONTAGEANLEIUNG

MANUAL DE MONTAJE

MONTAGEVOORSCHRIFT

ISTRUÇÕES DE MONTAGEM

ISTRUZIONI DI MONTAGGIO

ИНСТРУКЦИЯ ПО СБОРКЕ

Naputci za montažu

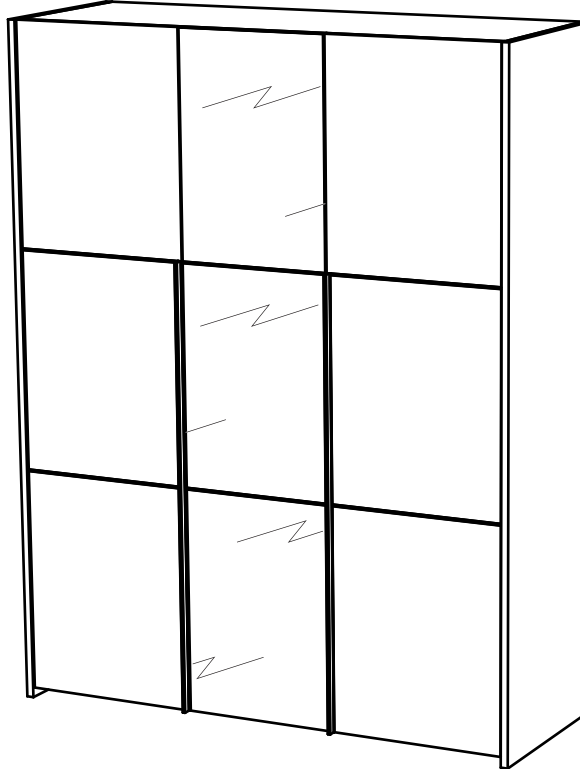

2H00

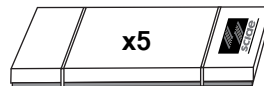

Package 1: 22 Kg

Package 2: 21 Kg

Package 3: 36 Kg

Package 4: 36 Kg

Package 5: 32 Kg

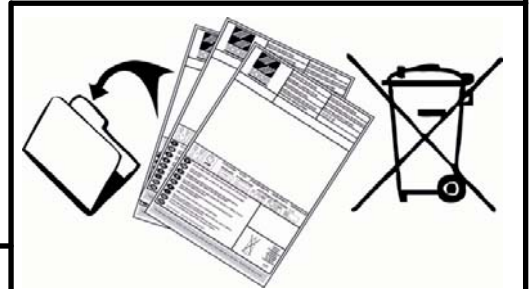

**F**

POUR L'APRES-VENTE, RETOURNEZ AU MAGASIN AVEC CETTE NOTICE

**GB**

FOR THE AFTER SALES, GO BACK TO THE SHOP WITH THIS ASSEMBLY INSTRUCTION

**D**

WENDEN SIE SICH BITTE AN IHREN HANDLER UND GEBEN SIE IHM DIE KENNUMMER DES MOBELS UND DIE TEILNUMMER

**E**

EN CASO DE SERVICIO POST-VENTA DEBEN DE VOLVER A LA TIENDA CON LAS INSTRUCCIONES DE MONTAJE

**NL**

VOOR SERVICE NA VERKOOP, GA NAAR UW LEVERANCIER MET DEZE MONTAGE HANDLEIDING

**P**

PARA O POS VENDA, VOLTE A LOJA COM ESTA FOLHA

**I**

SERVIZIO POST VENDITA: E NECESSARIO PRESENTARSI SUL PUNTO VENDITA CON QUESTE ISTRUZIONI DI MONTAGGIO

**RU**

ДЛЯ ПОСЛЕПРОДАЖНОГО ОБСЛУЖИВАНИЯ ПРОСЬБА ОБРАТИТЬСЯ В МАГАЗИН ПРЕДЪЯВИВ НАСТОЯЩУЮ ИНСТРУКЦИЮ ПО СБОРКЕ

**HR**

U SLUČAJU REKLAMACIJE, VRATITE SE NA PRODAJNO MJESTO S OVIM UPUTAMA ZA MONTAŽU

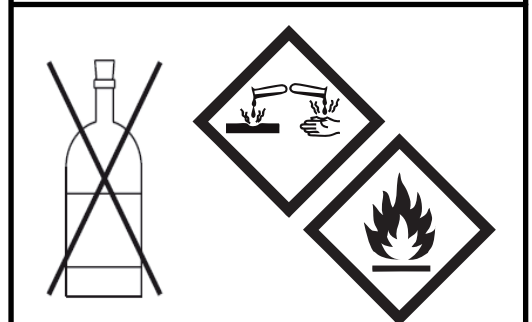
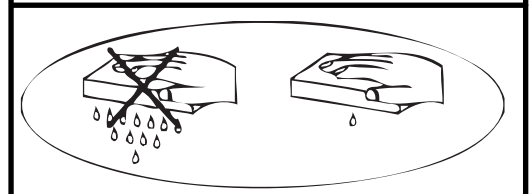

+40°C  
+104°F

+15°C  
+59°F

HYGROMETRIE  
HYGROMETRY

40%-65%

1 an  
1 year

OK

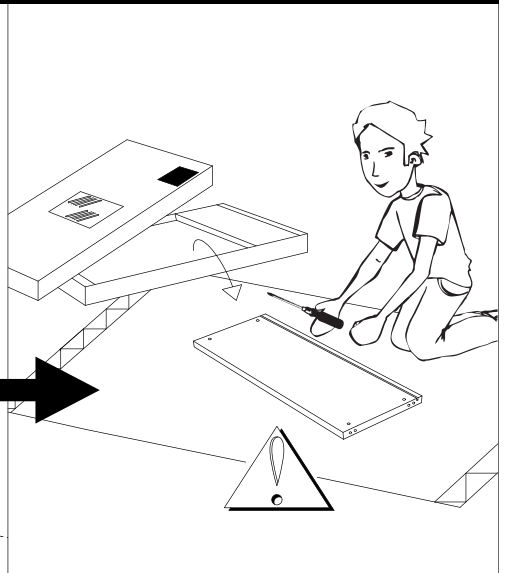
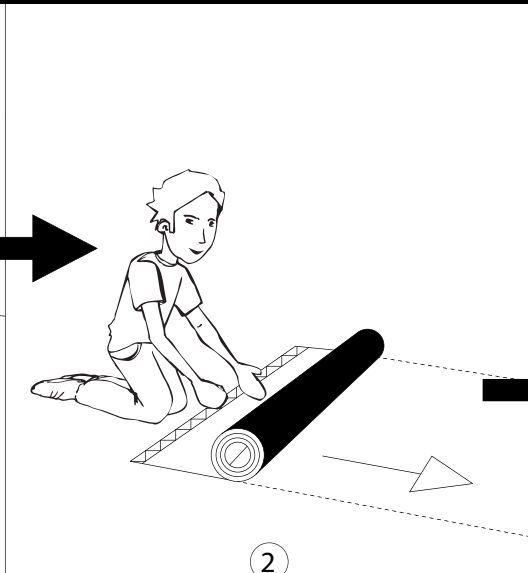
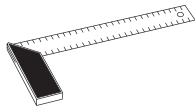
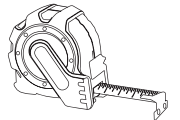
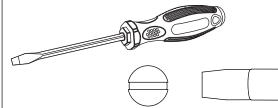
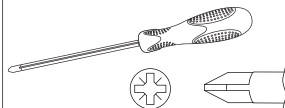
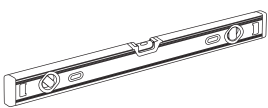
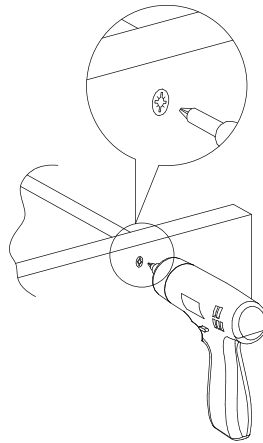
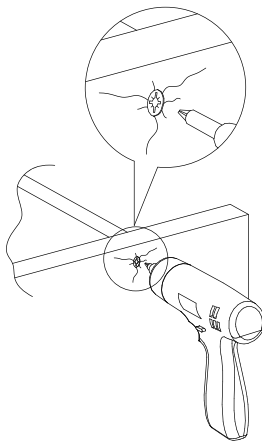
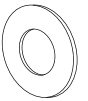
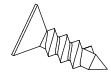
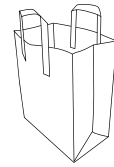
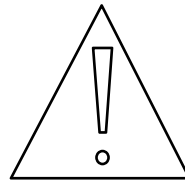

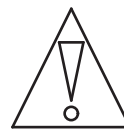
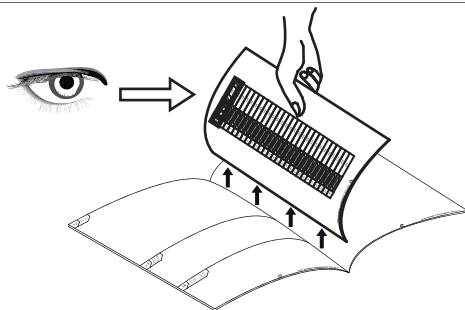

1

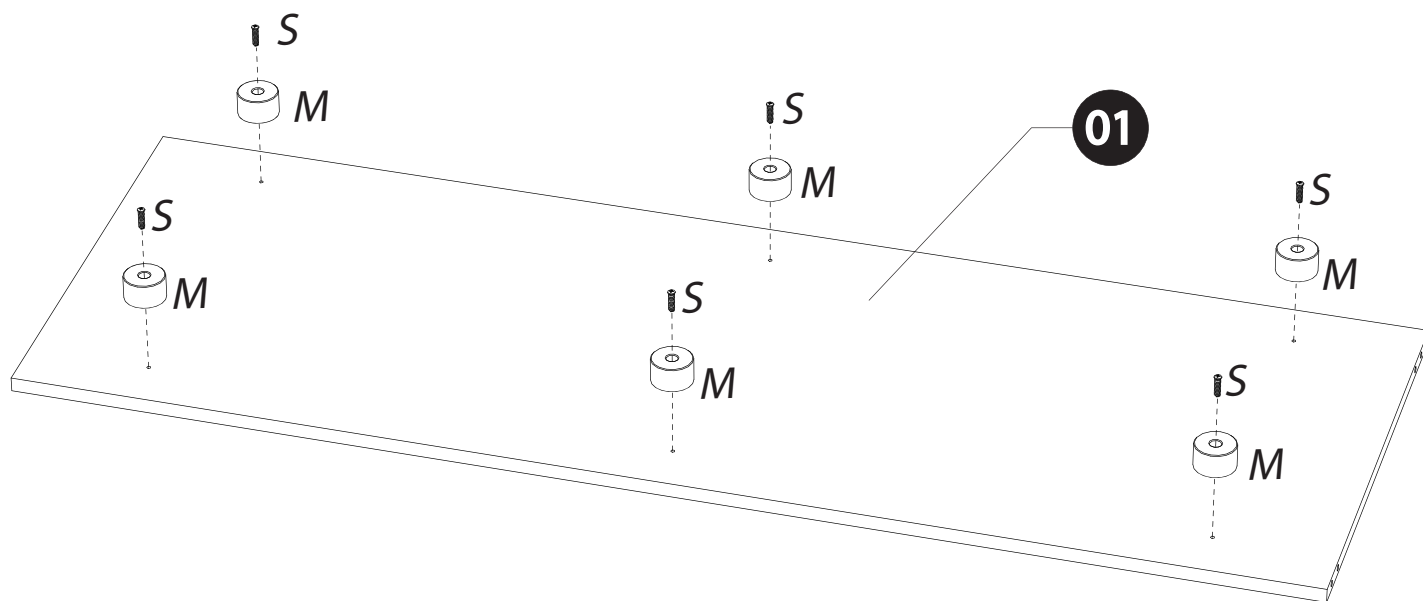
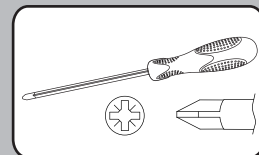
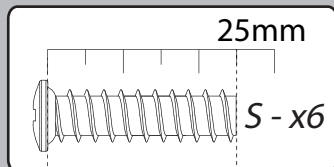
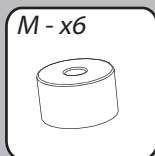

2

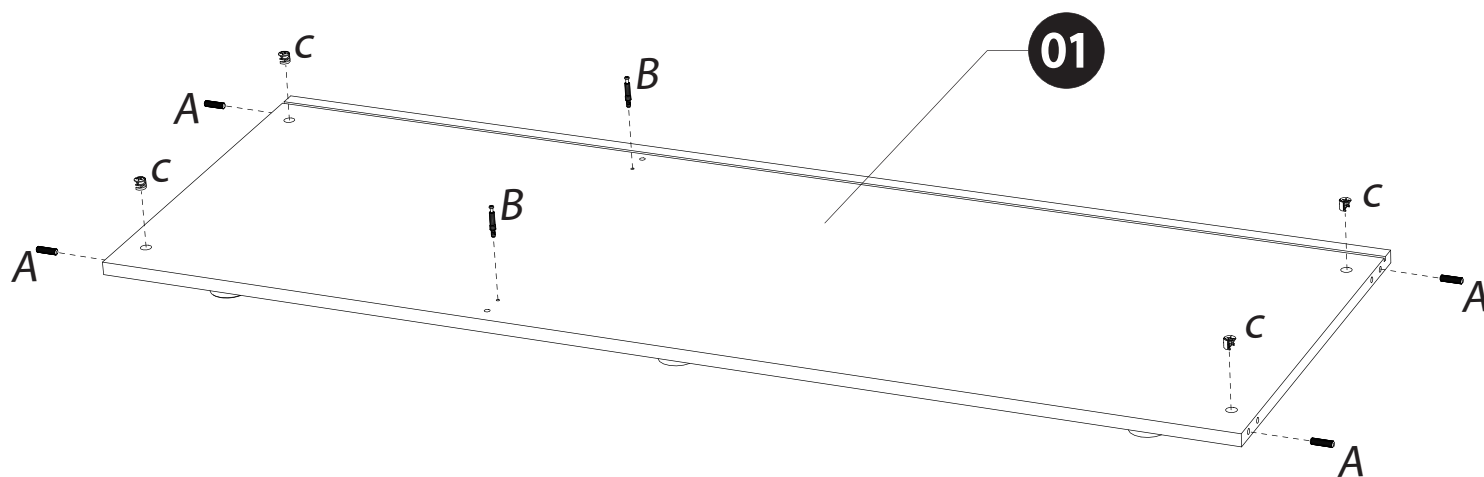
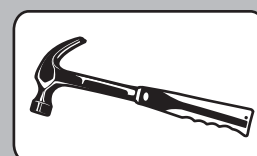
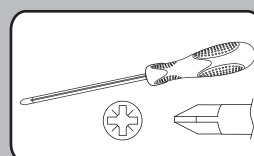
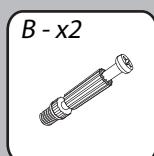
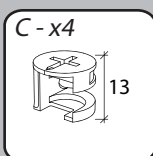
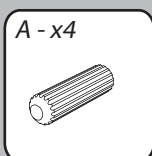

3

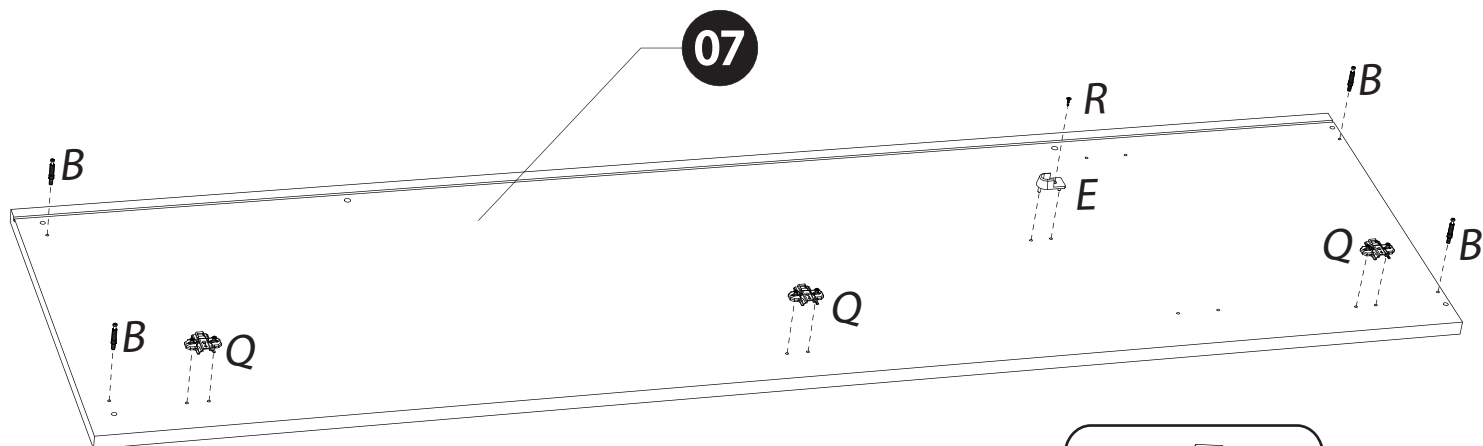
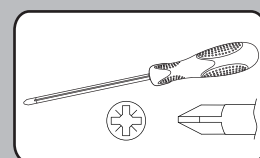
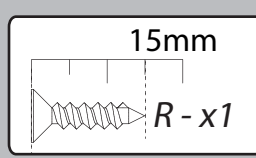
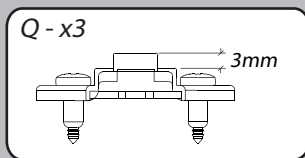
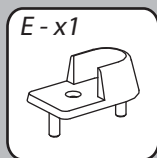
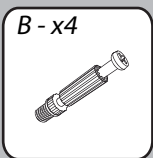

4

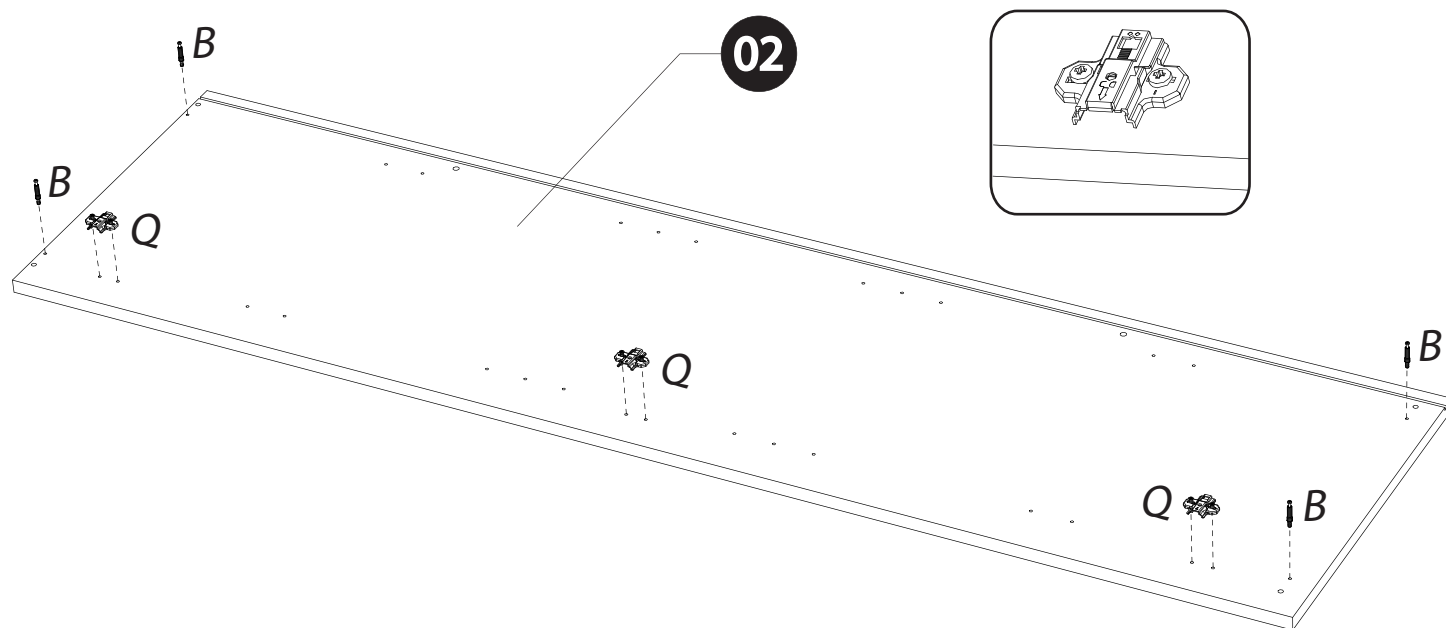
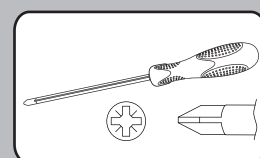
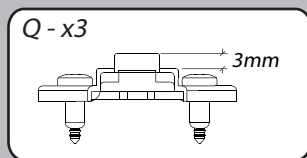
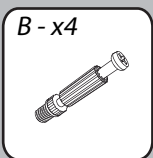

# 5

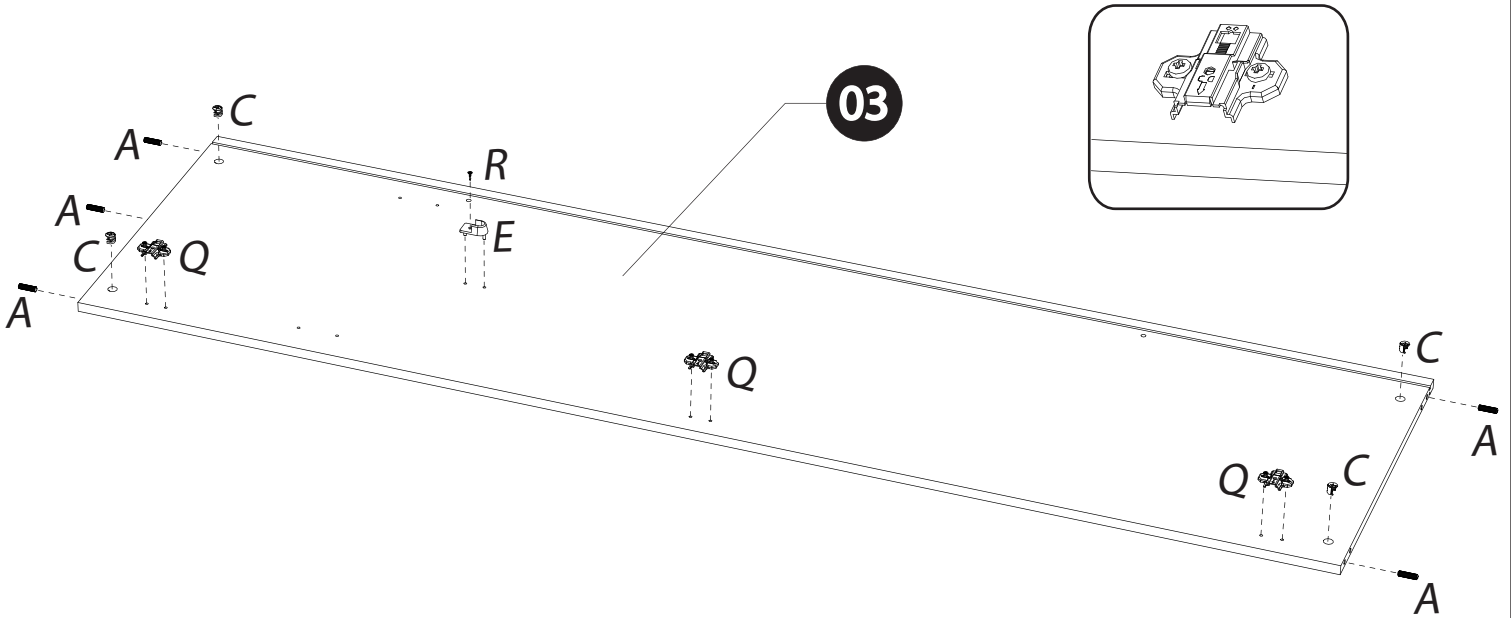
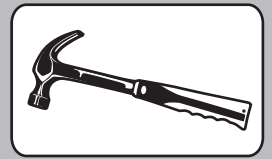
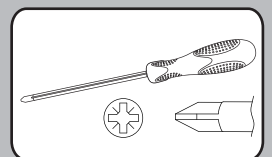
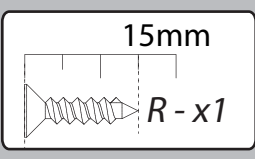
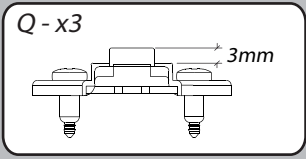
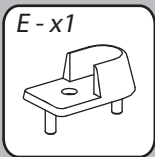
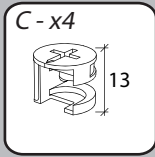
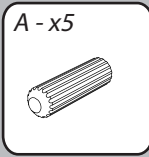

# 6

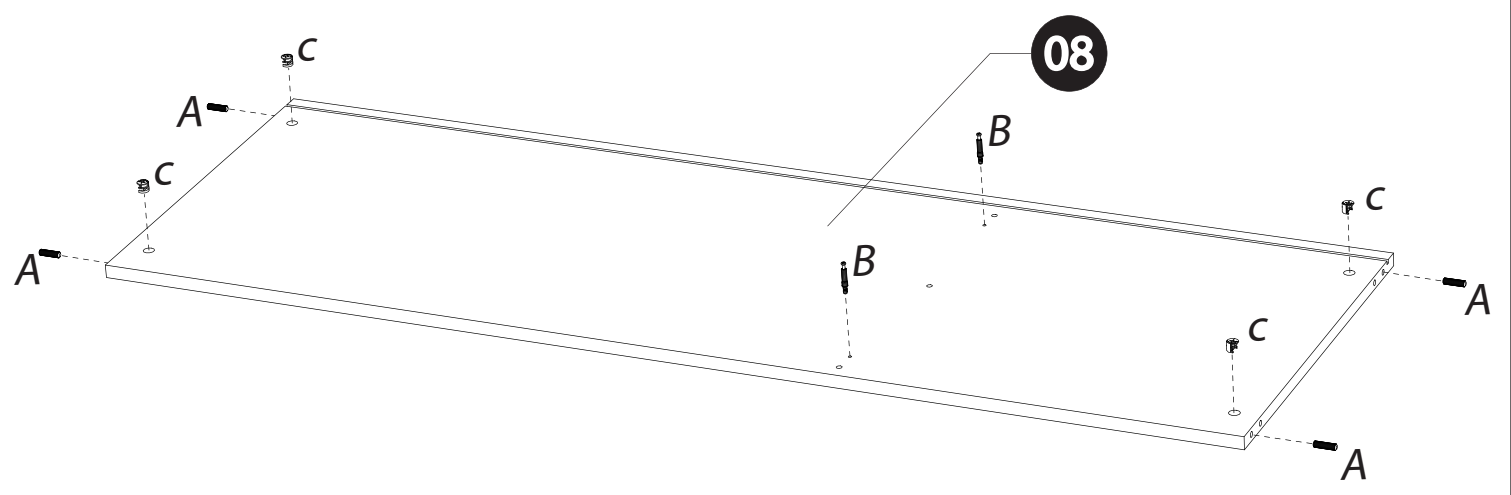
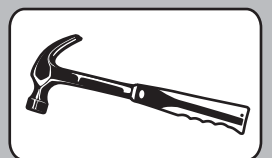
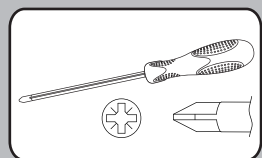
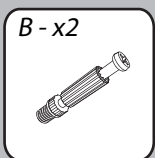
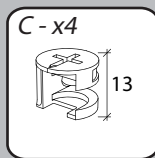
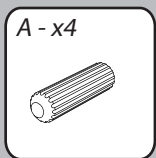

# 7

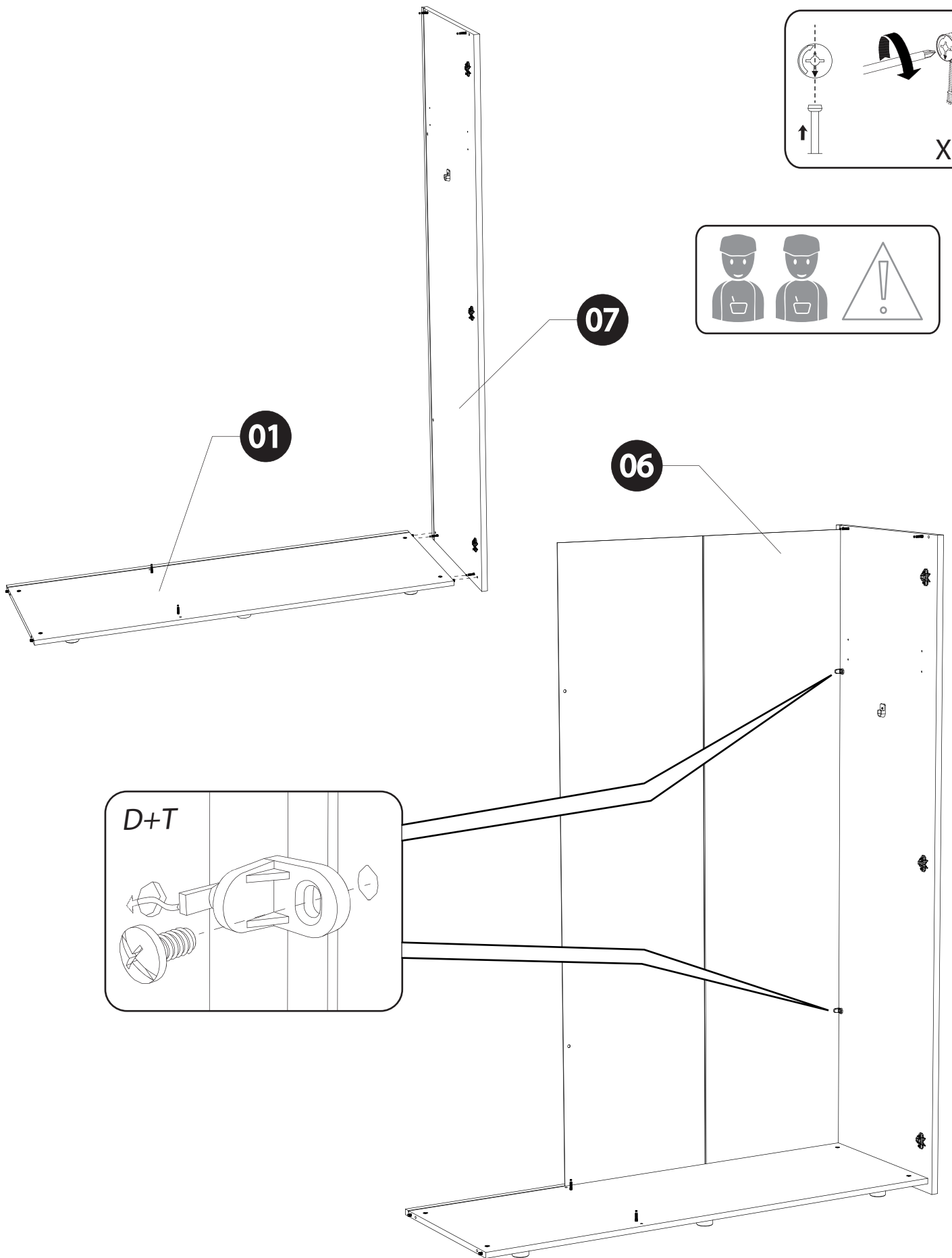
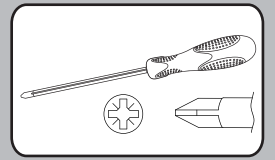
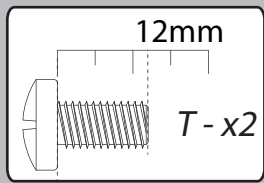
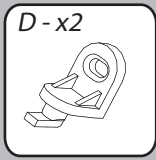

8

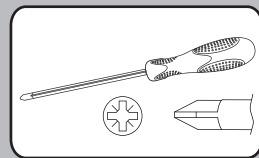
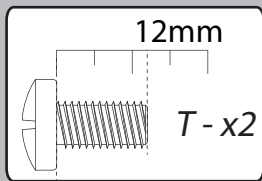
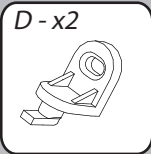



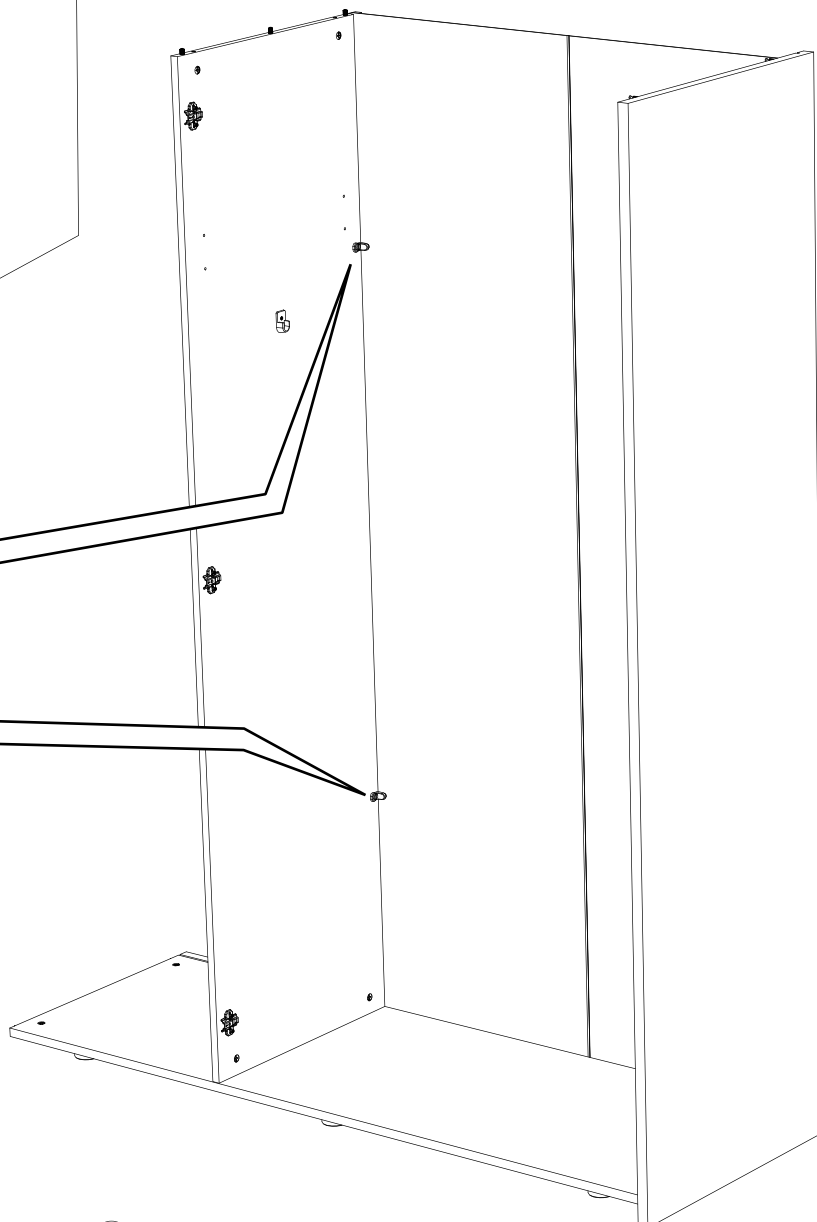
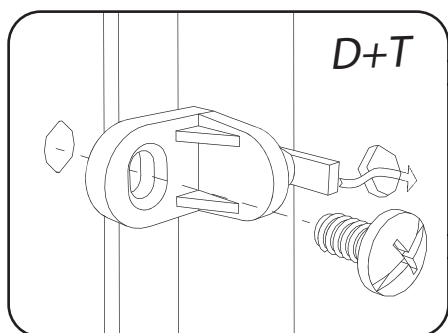
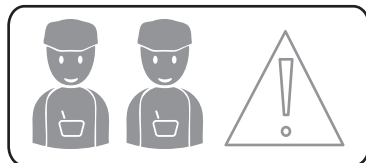
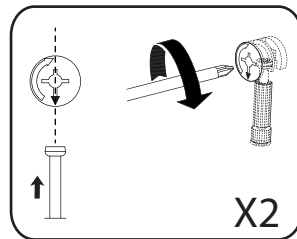

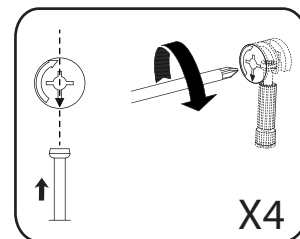
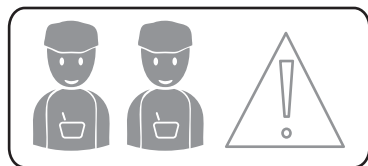
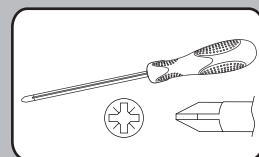



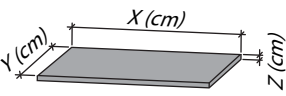
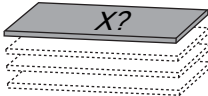
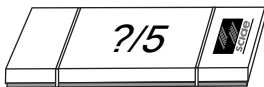

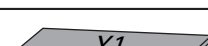

03

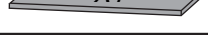





<i>DESIGNATION</i>		<i>N°</i>		
Dessous	157.6 x 54.5 x 1.8	1		2
Côté gauche	208.8 x 56.8 x 2.2	2		3
Séparation	202.4 x 54.3 x 1.6	3		5
Derrière pliant de penderie	203.2 x 103.5 x 0,25	6		4
Côté droit	208.8 x 56.8 x 2.2	7		3
Dessus	157.6 x 54.5 x 1.6	8		2
Tablette penderie	102.6 x 51.5 x 2.2	9		1
Porte gauche	205.8 x 54.7 x 1.8	10		4
Porte droite	205.8 x 54.7 x 1.8	11		4
Porte centrale	205.8 x 47 x 1.6	Z1		5
Tablette lingère	53.3 x 51.5 x 1.6	19		1
Derrière lingère	203.2 x 54.4 x 0.25	26		4

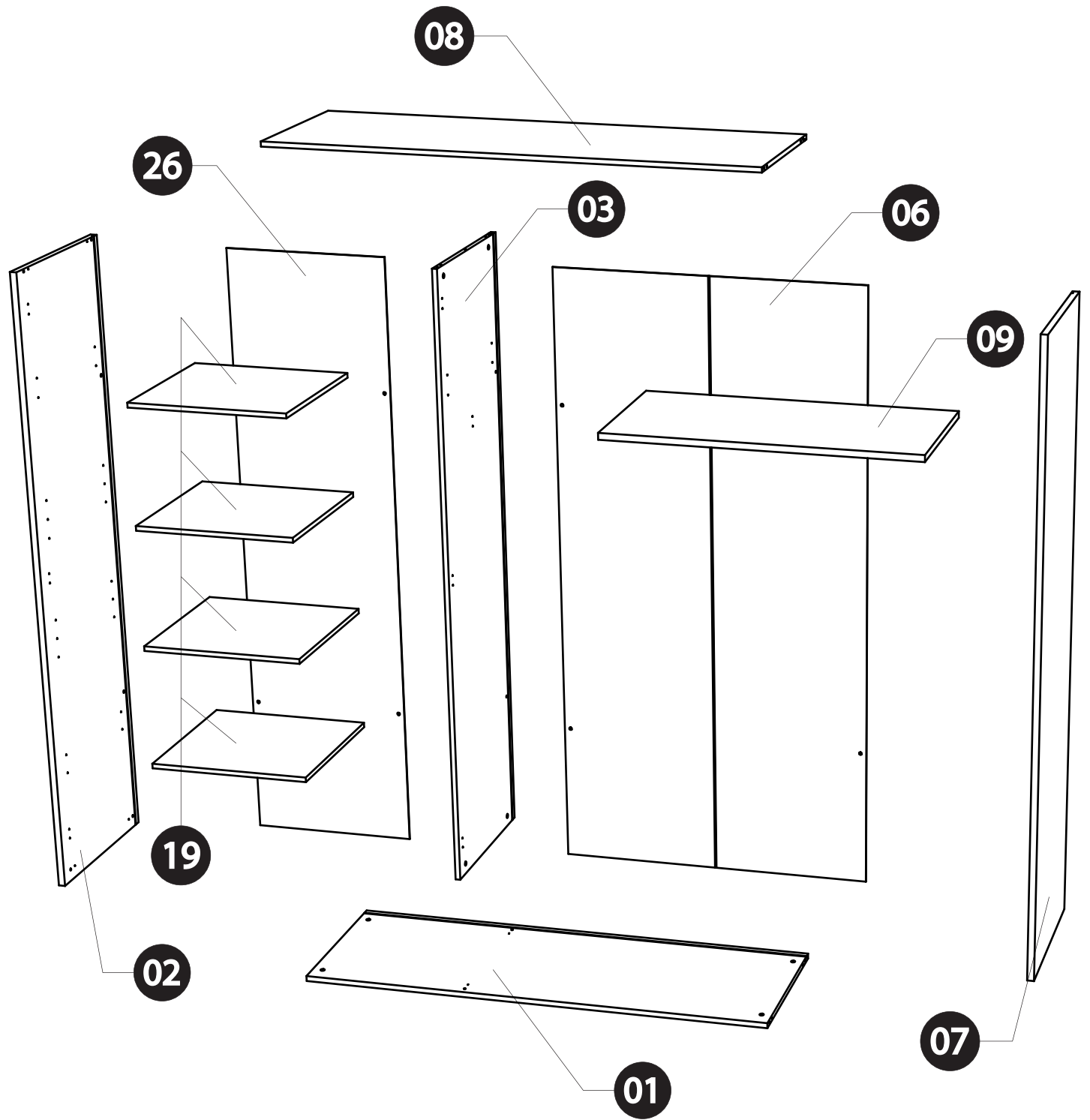

10

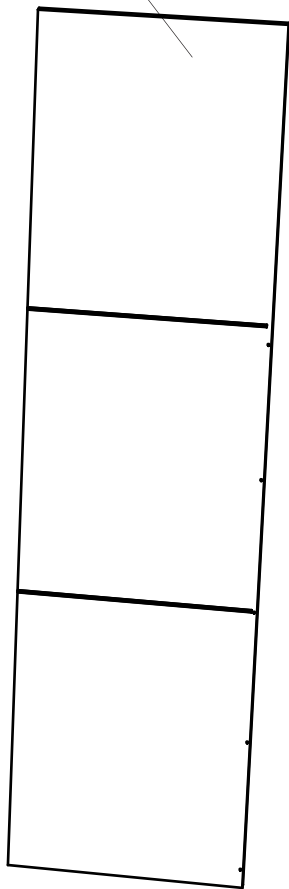

Z1

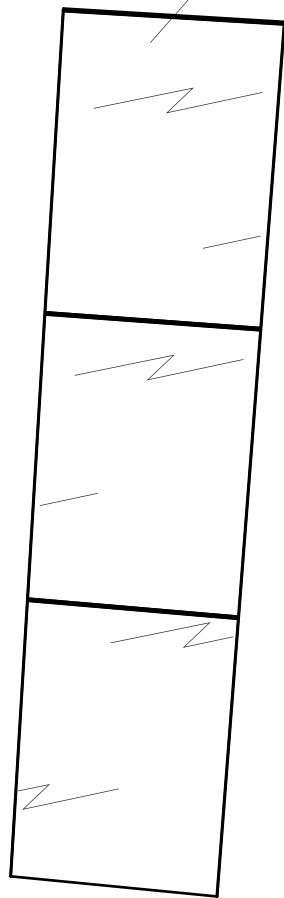

11

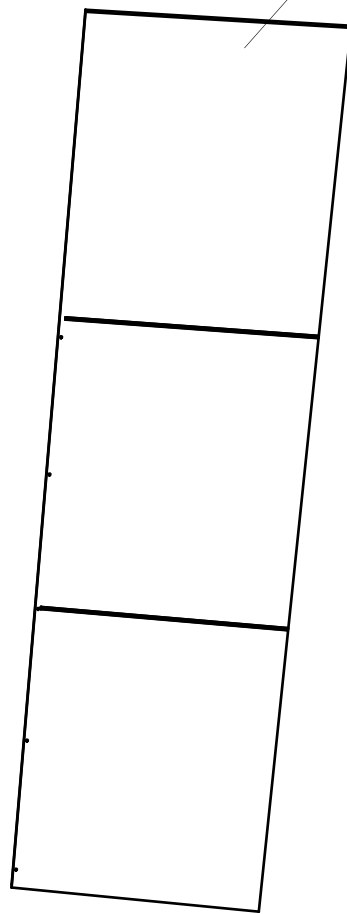

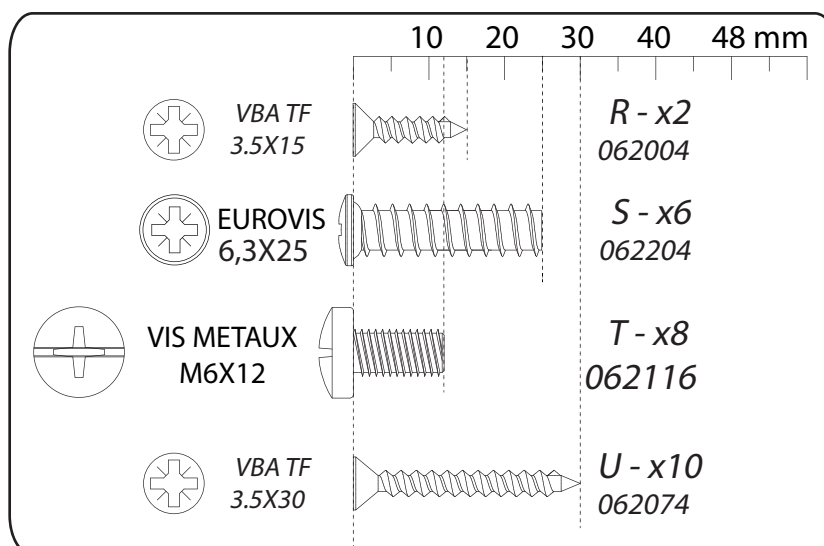
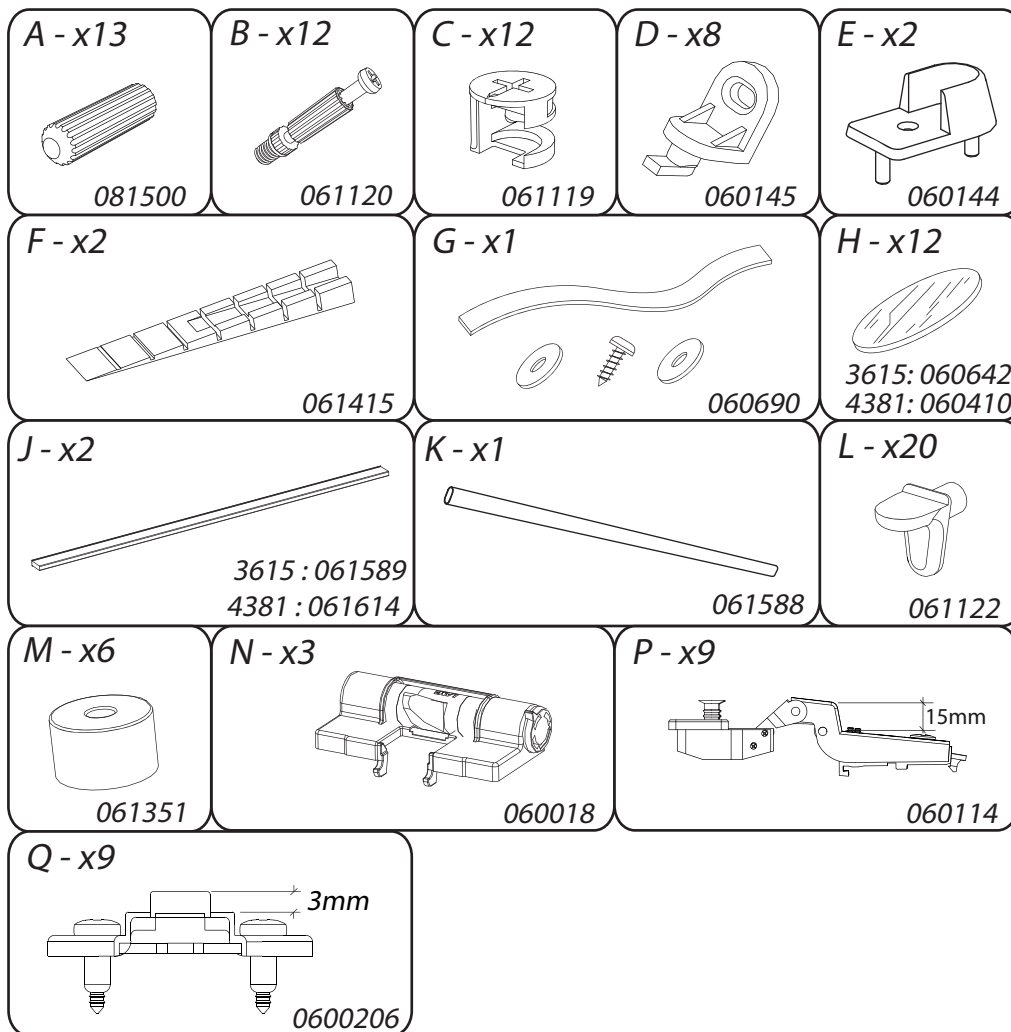

# 10

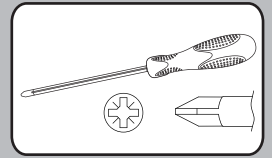
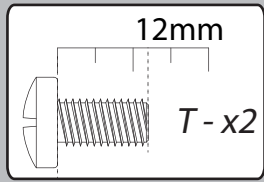
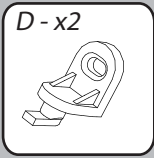

26

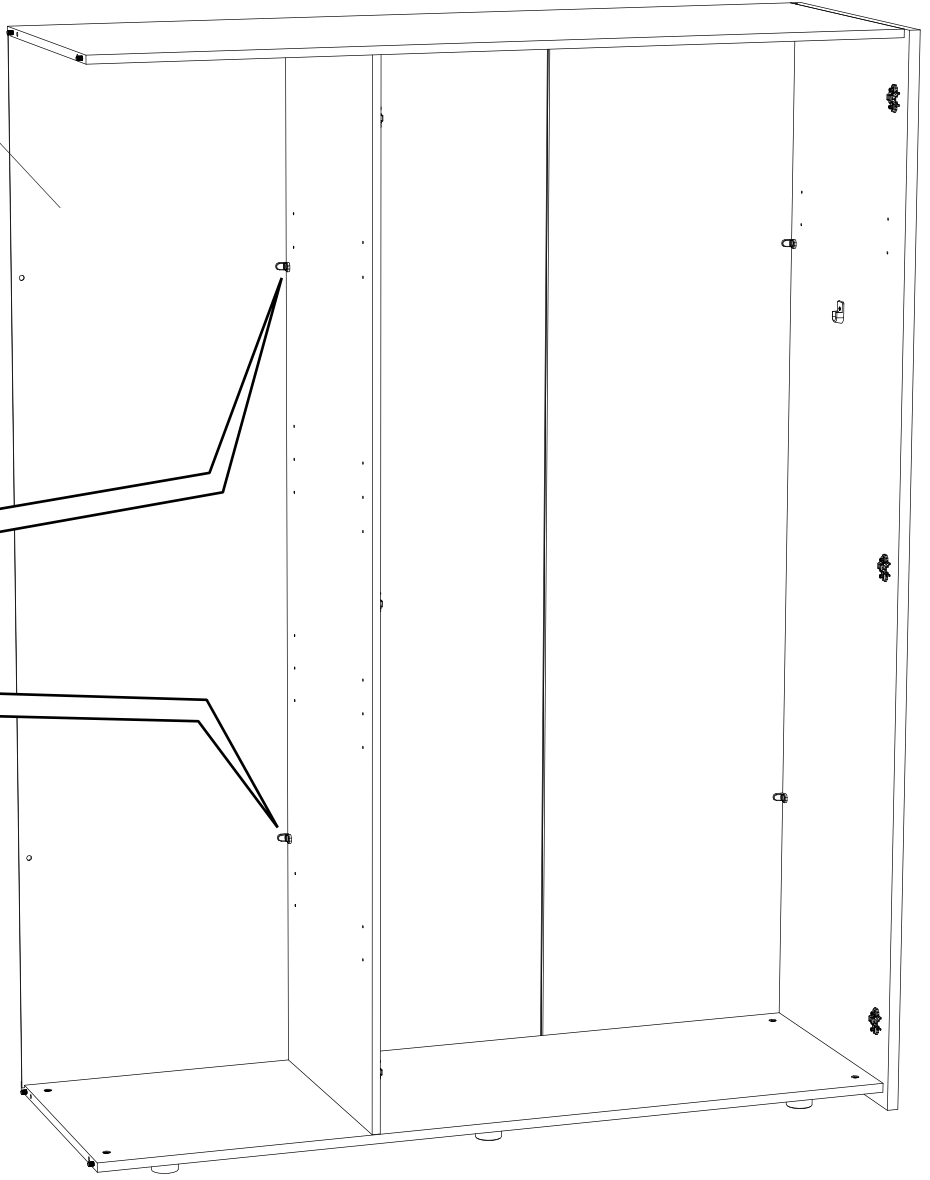
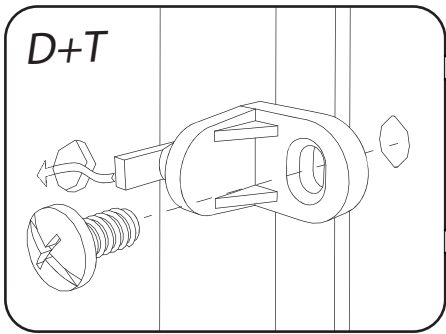

# 11

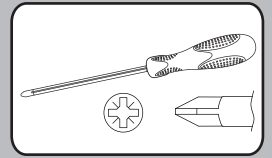
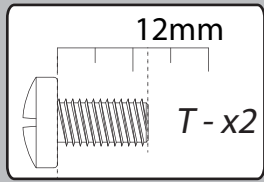
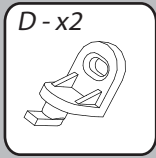

02

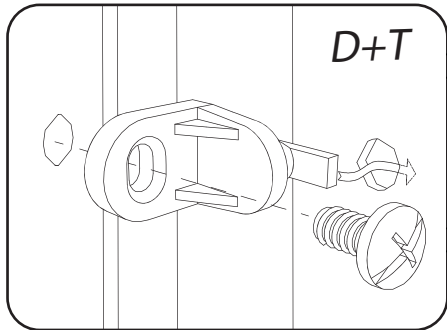
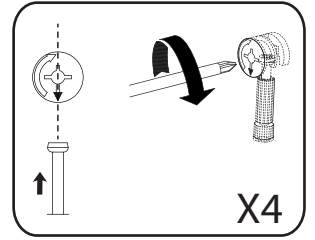
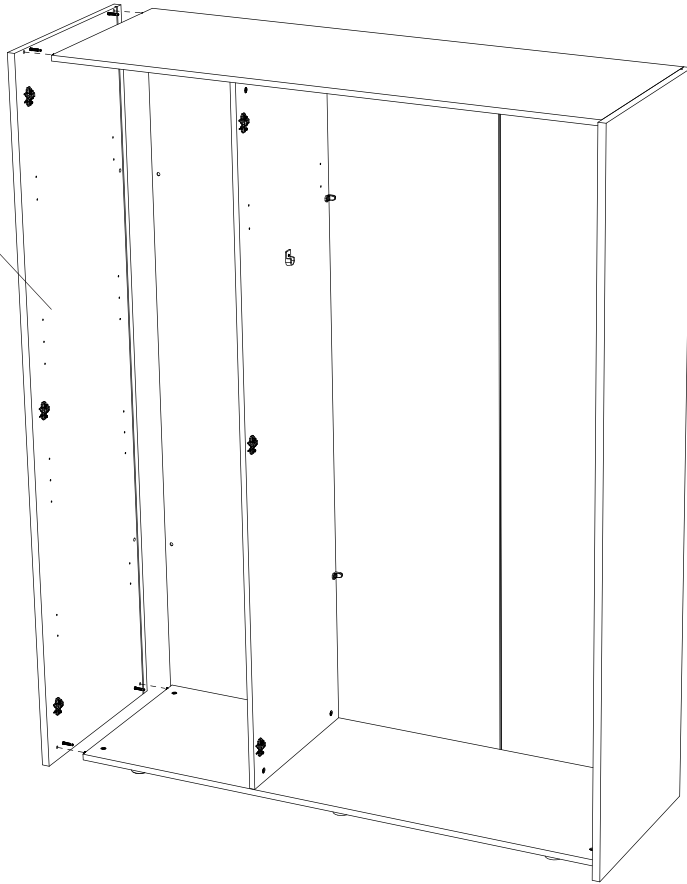

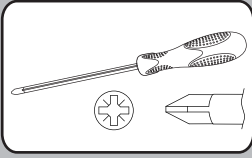
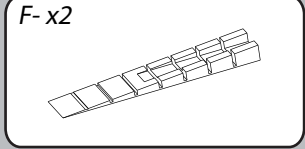
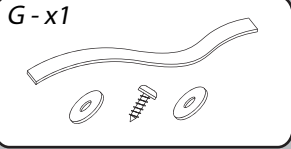

FRANCAIS: Pour votre sécurité il est impératif de fixer votre meuble au mur.  
 ENGLISH: For your own safety, this furniture must be fastened to the wall imperatively.  
 DEUTSCH: Zu Ihre Sicherheit, ist es notwendig Ihr Möbel auf dem Wand zu fixieren.

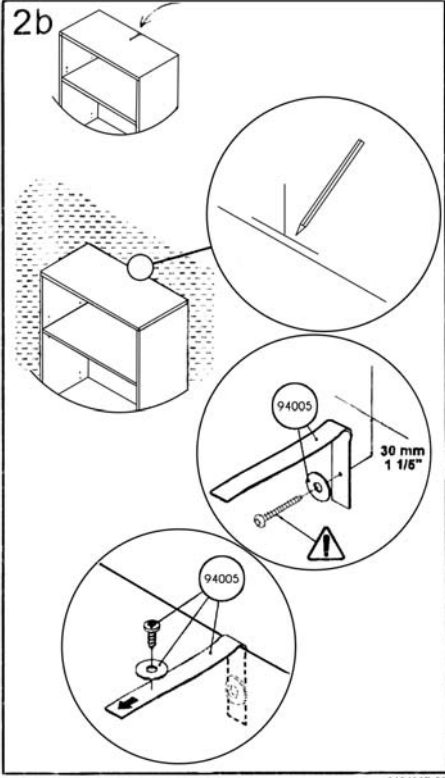
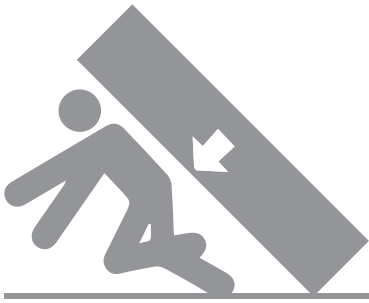

FRANCAIS  
**IMPORTANT:** La vis fournie avec le dispositif anti-bascule est destinée à fixer le dispositif dans le meuble. Pour la fixation au mur, compléter par une vis adaptée au support mural. En cas de doute, contacter un magasin de bricolage.

ENGLISH  
**IMPORTANT:** The screw supplied together with the anti-topple bracket is to be used only for fixing the anti-topple bracket to the furniture. In addition to this, you will need to choose a screw or fitting which is suitable for securing the bracket to the kind of walls you have. If you are unsure about what type of screw to use contact your local hardware store.

DEUTSCH  
**WICHTIG:** Die dem kippschutz beigefügten schrauben sind ausschließlich für die befestigung des kippschutzes am möbelstück vorgesehen. Für die befestigung des kippschutzes an der wand benötigen sie zusätzlich schrauben oder beschläge, die zur beschaffenheit der wand passen. Falls sie nicht sicher sind, welche art von schrauben geeignet sind, wenden sie sich bitte an den fachhandel.

0194607-50

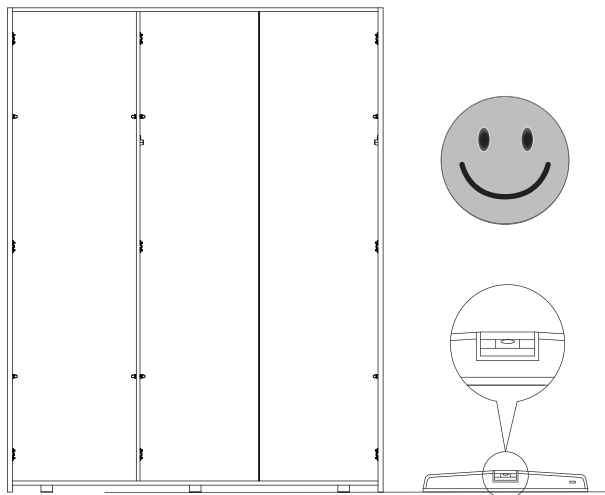
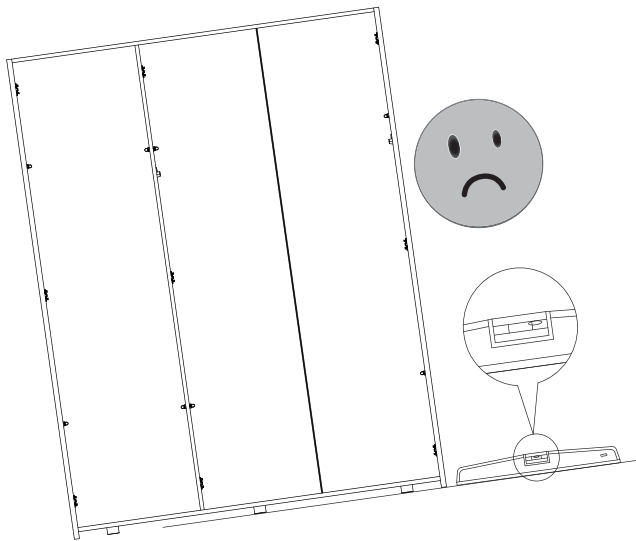
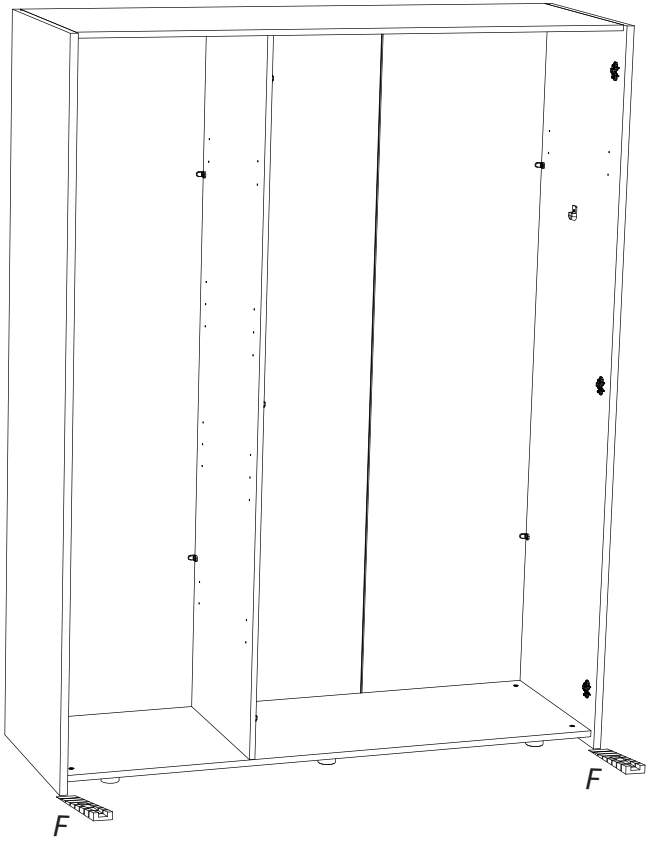

# 13

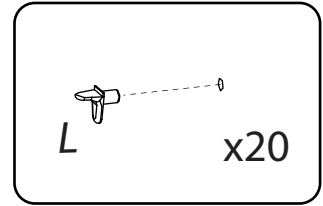
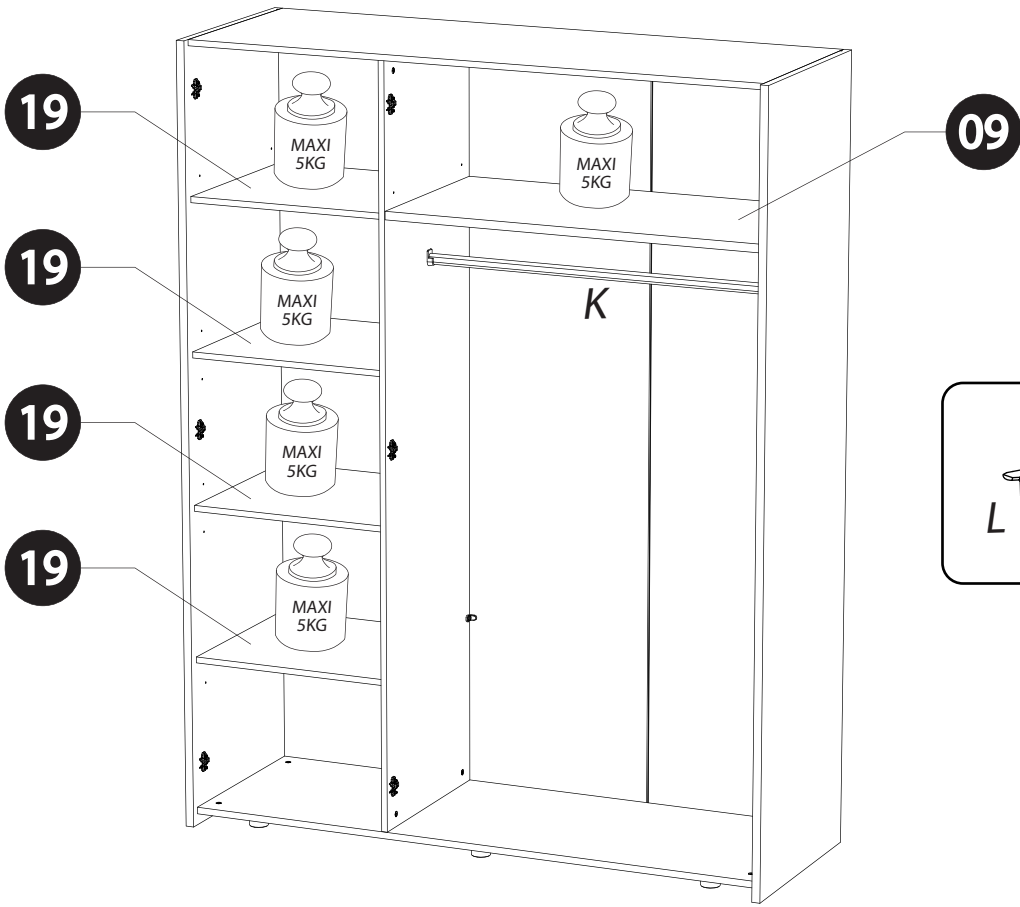
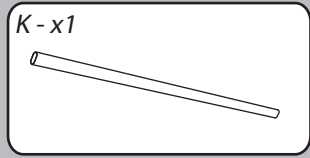
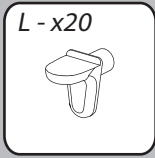

# 14

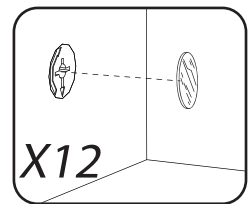
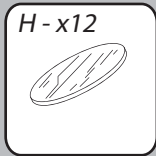



P - x9

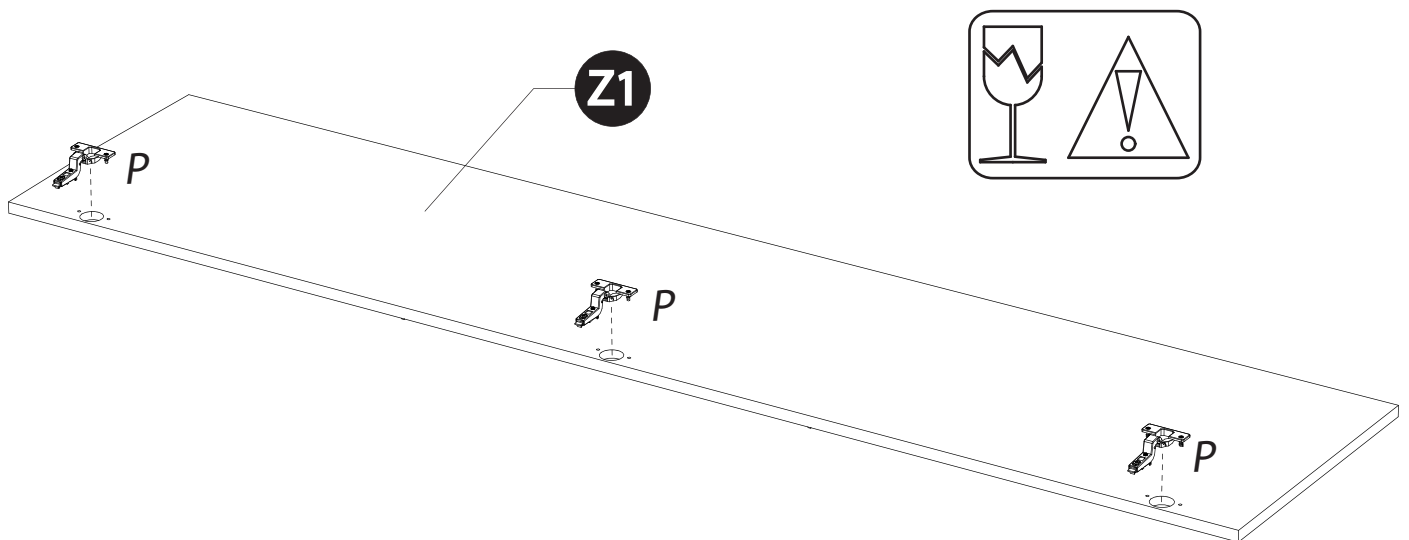
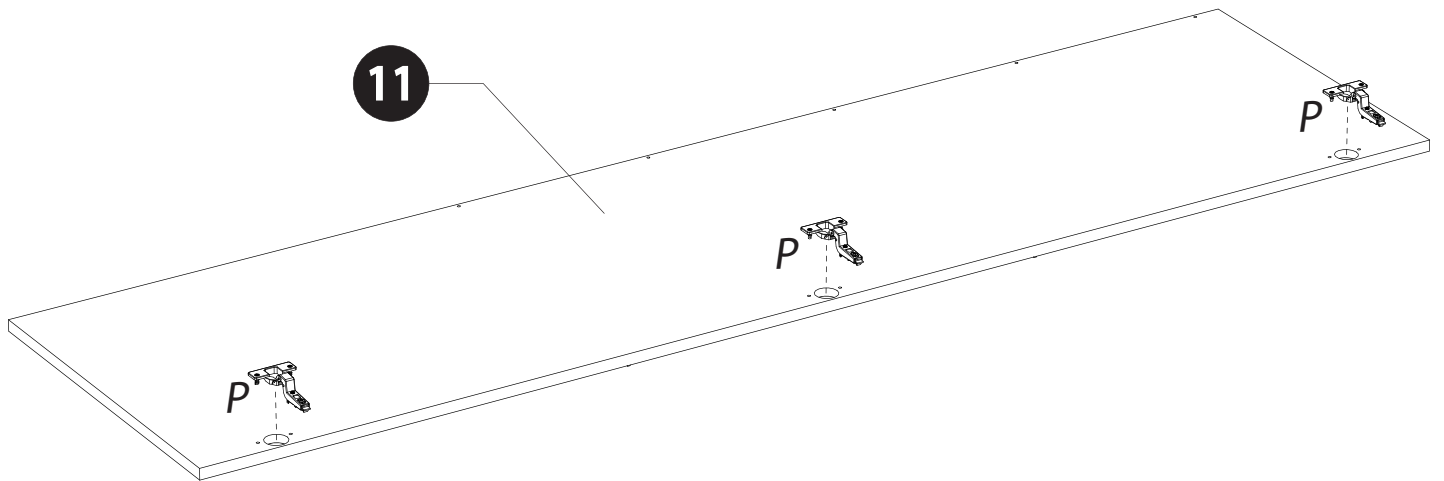
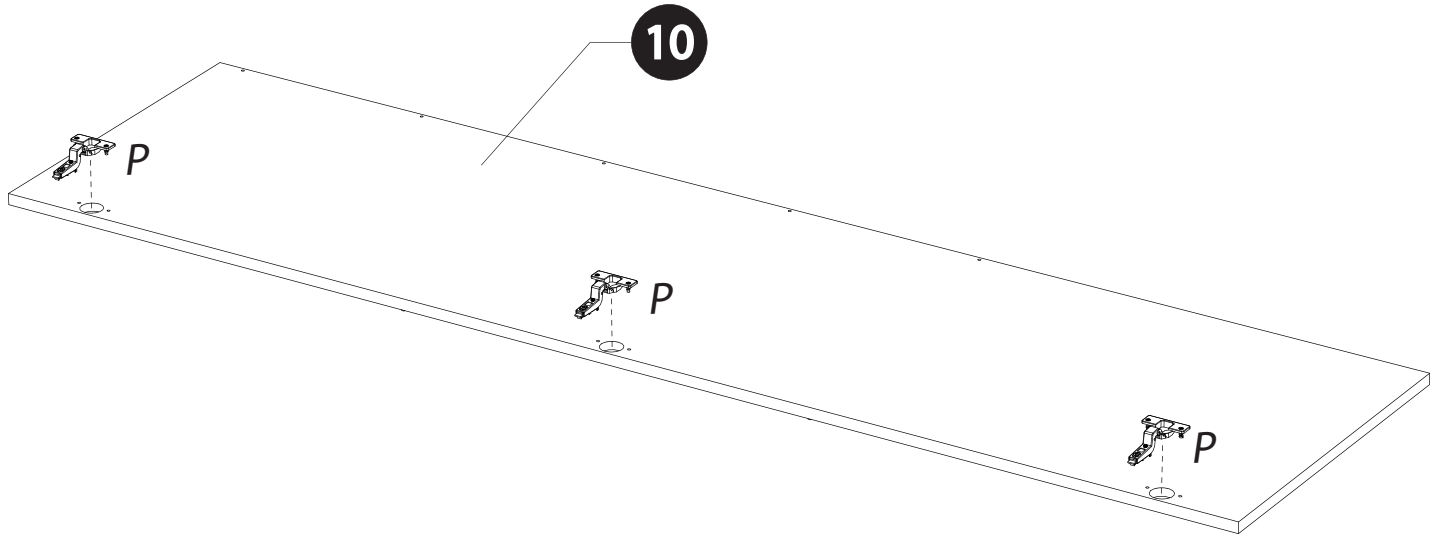
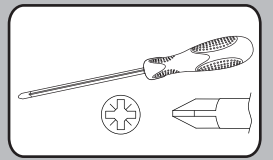
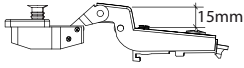

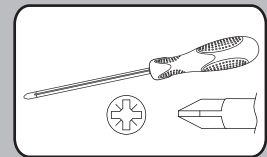
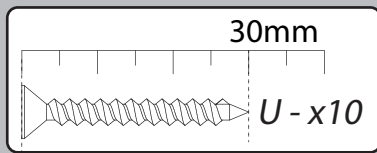
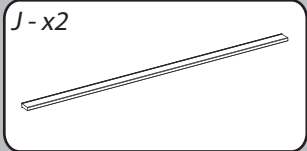

10

11

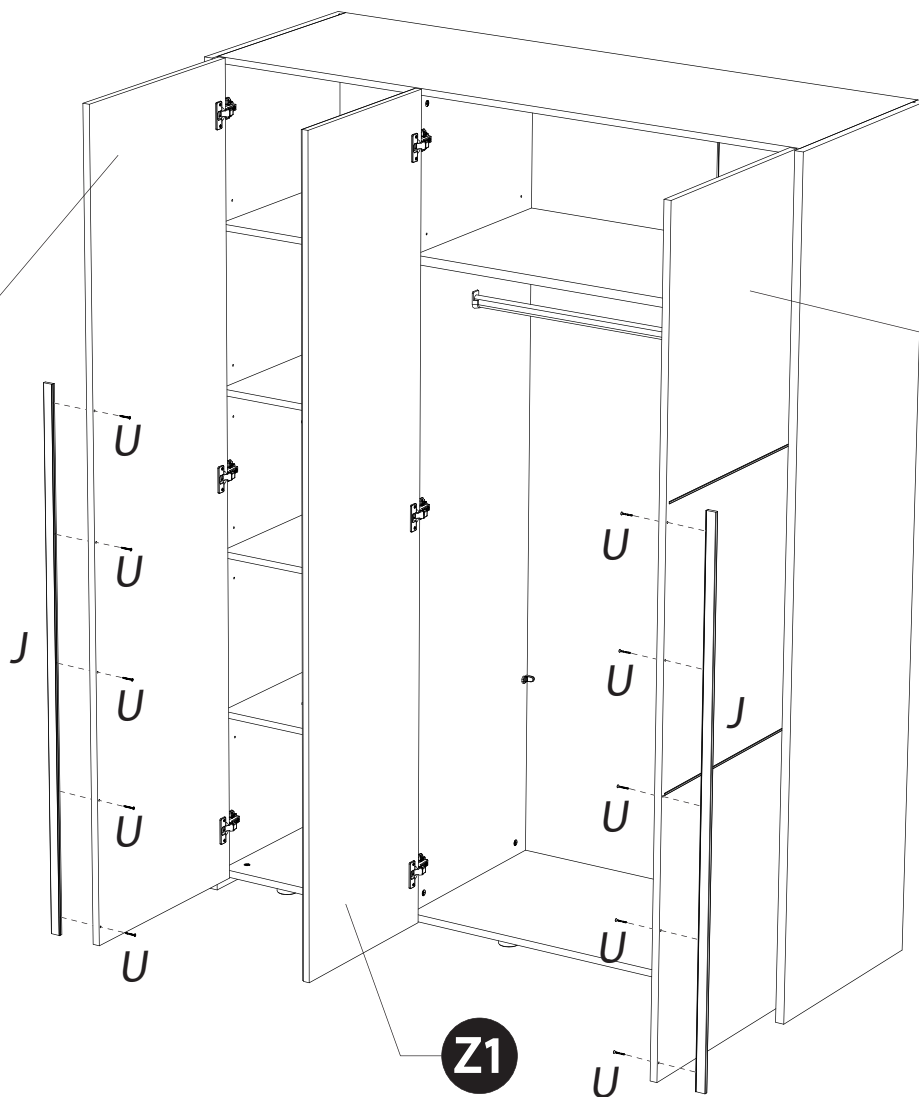

Z1

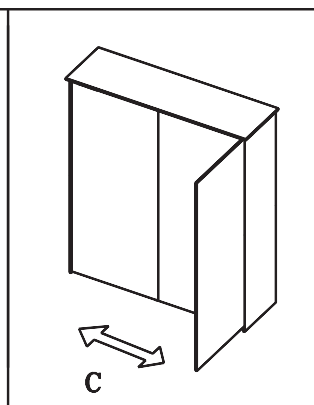
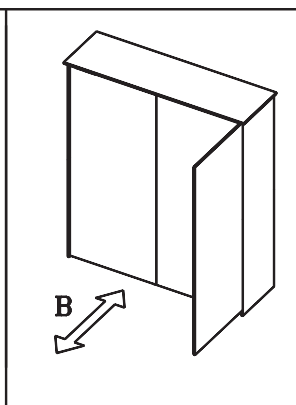
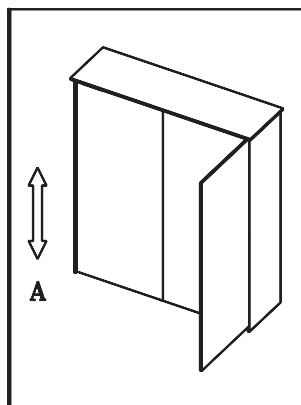
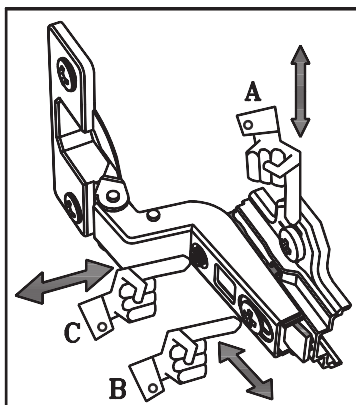
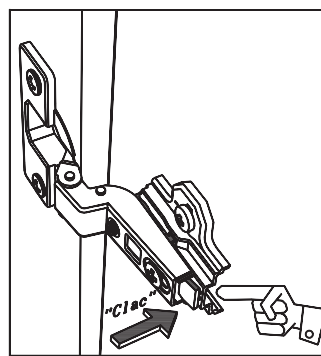
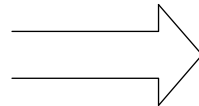
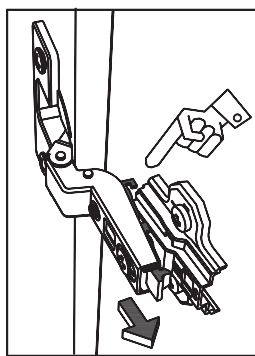
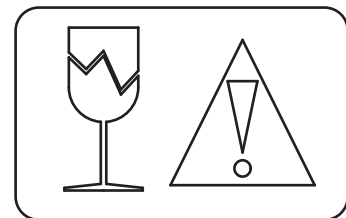

N - x3

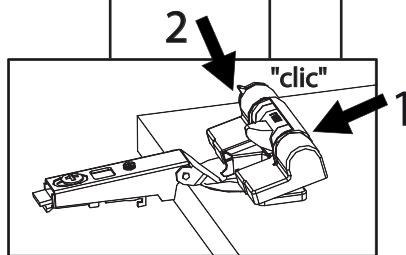
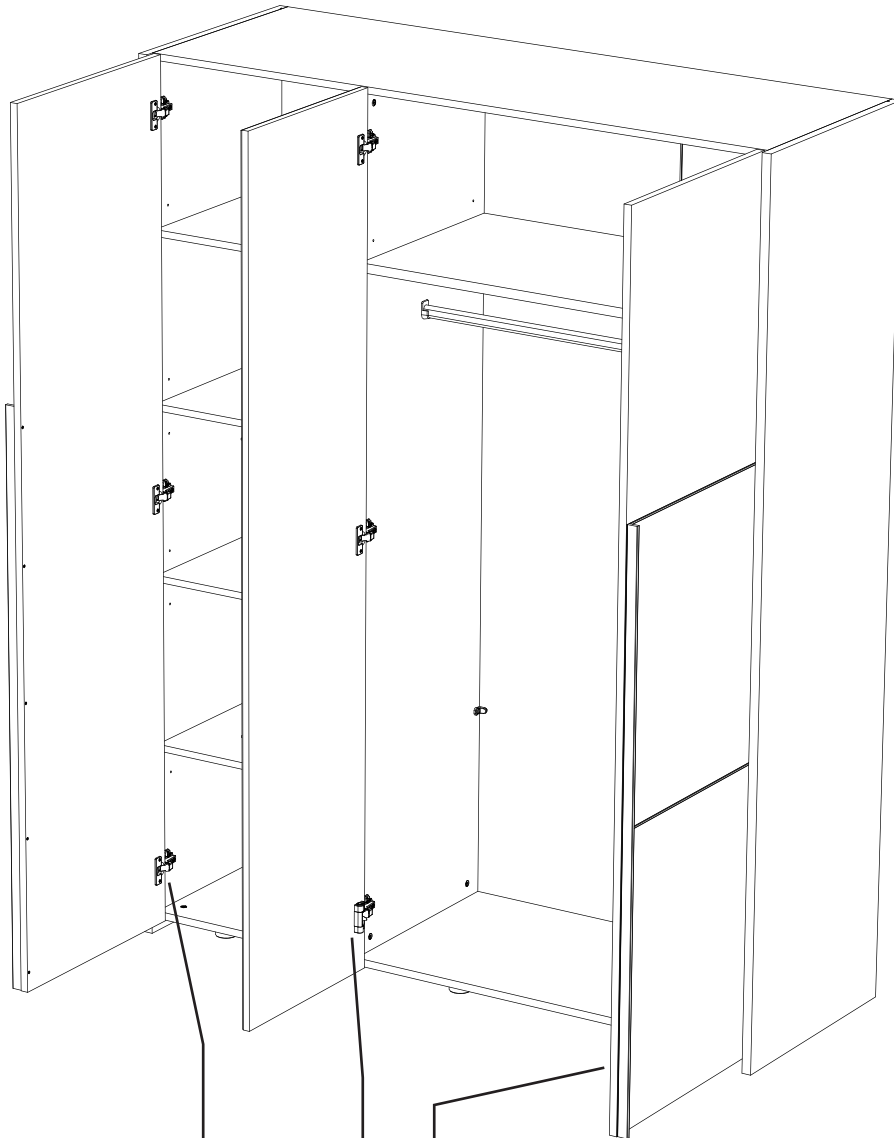
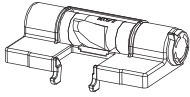

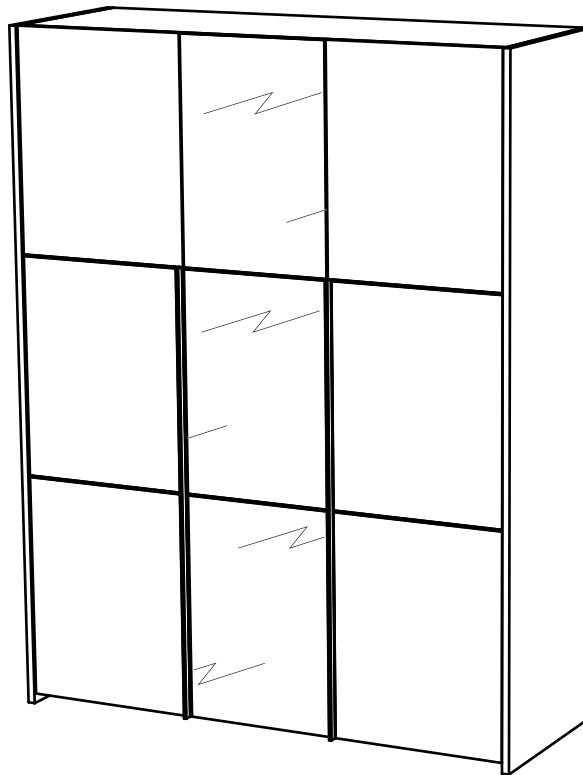

PRADO 3615:

Armoire 3po 1g composé de panneaux de particules revêtus papier blanc (laqués blanc brillant pour la porte gauche et droite) et revêtus papier noir.  
Ajout de profils PVC Gris moonstone brillant.  
L.162 cm - H.209 cm - P.57 cm.  
A monter soi-même.

PRADO 4381:

Armoire 3po 1g composé de panneaux de particules revêtus papier décor Oak endgrain et papier blanc (laqués blanc mat pour la porte gauche et droite).  
Ajout de profils PVC Blanc mat.  
L.162 cm - H.209 cm - P.57 cm.  
A monter soi-même.

FRANCAIS

Recommandations de démontage :

En cas de déménagement, il convient de procéder au démontage de votre meuble, en ôtant toute la visserie.

ENGLISH

Disassembly advices:

In case of moving, it is needed to dismantle the furniture removing the fittings.

DEUTSCH

Empfehlungen für die Demontage:

Bei Transport bitte alle Beschläge demontieren.

"Les meubles contenant des panneaux à base de bois (panneaux de particules, panneaux de fibres, contreplaqué...) peuvent émettre des substances polluantes dans l'air intérieur. Il est ainsi recommandé, après l'installation du meuble dans son logement, d'aérer fréquemment la pièce concernée pendant au moins quatre semaines afin de réduire son exposition aux polluants émis par le meuble."