

# ASSEMBLY INSTRUCTIONS

88214

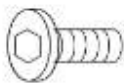

[A]× 8 PCS



M6×20

[B]×6PCS

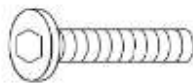

M6×45

[C]× 5PCS

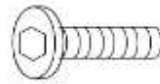

M6×35

[D]×3PCS

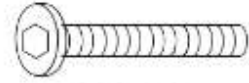

M6×55

[E]×14 PCS



M6

[I]×12PCS



[F]×1PCS



[J]× 4PCS



[G]×1PCS



[H]×24PCS



STEP1

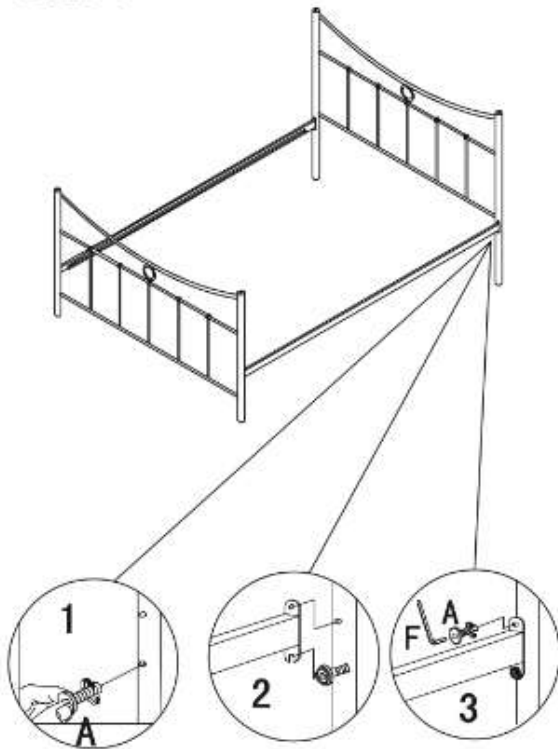

STEP2

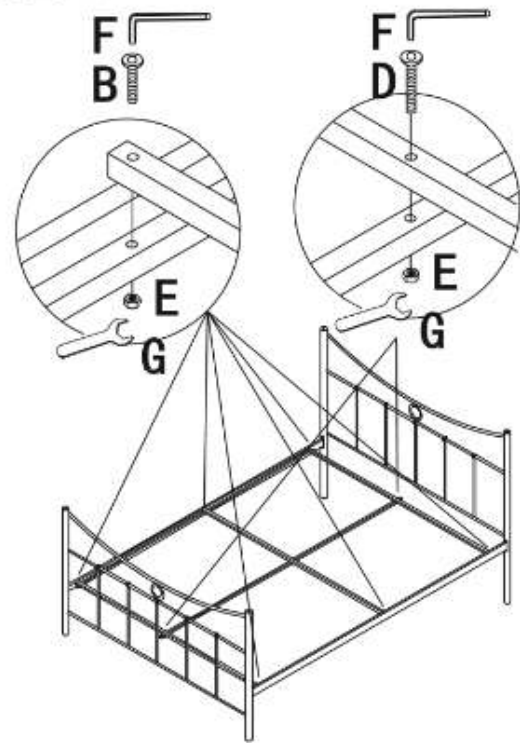

STEP3

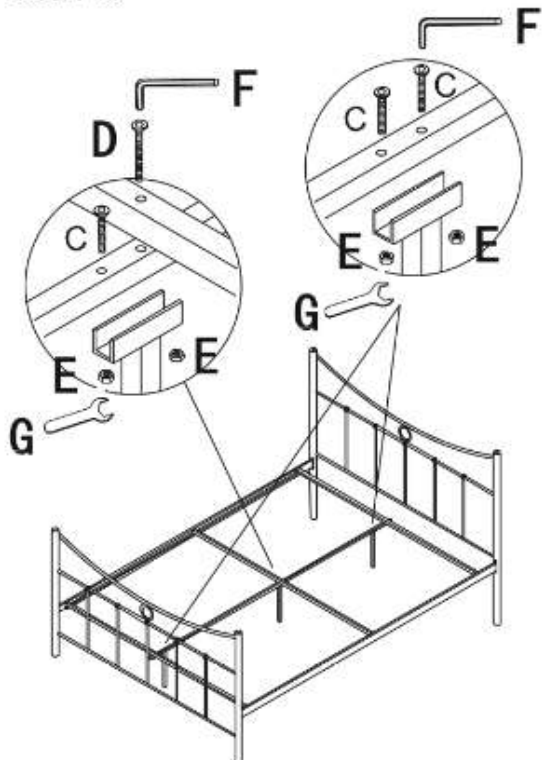

STEP4

