

A	B	C	D
1	S19-129/B	758x285	1/1
2	S19-130/B	758x285	1/1
3	S19-211	595x292	1/1
4	S19-323	561x279	1/1
5	S19-324	560x279	1/1
6	S19-414	561x70	1/1
7	S19-924	696x577	1/1

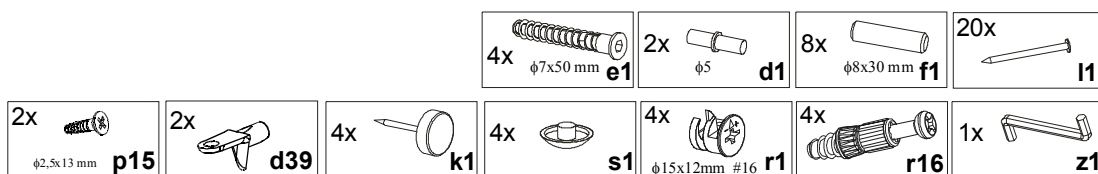

1

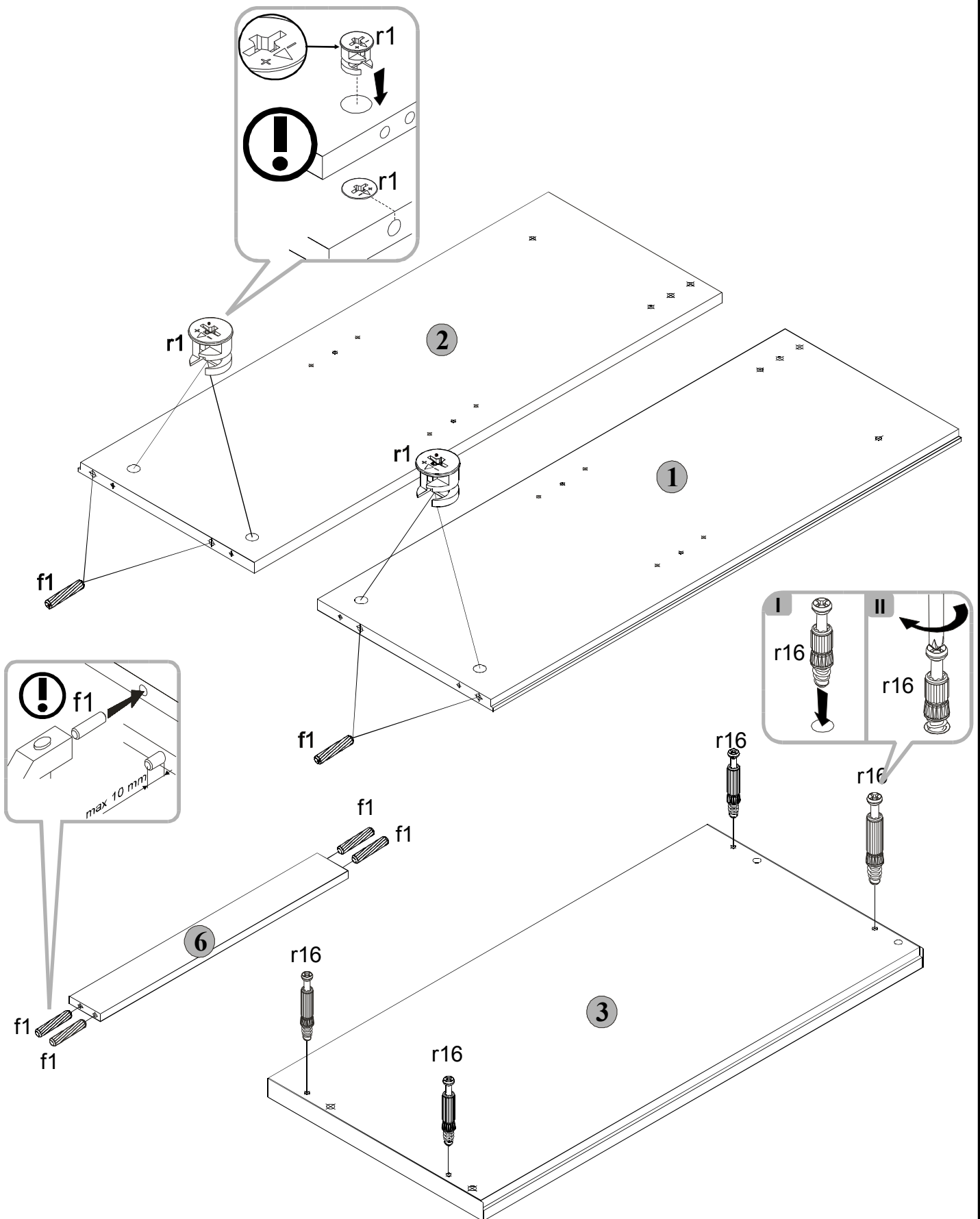

2

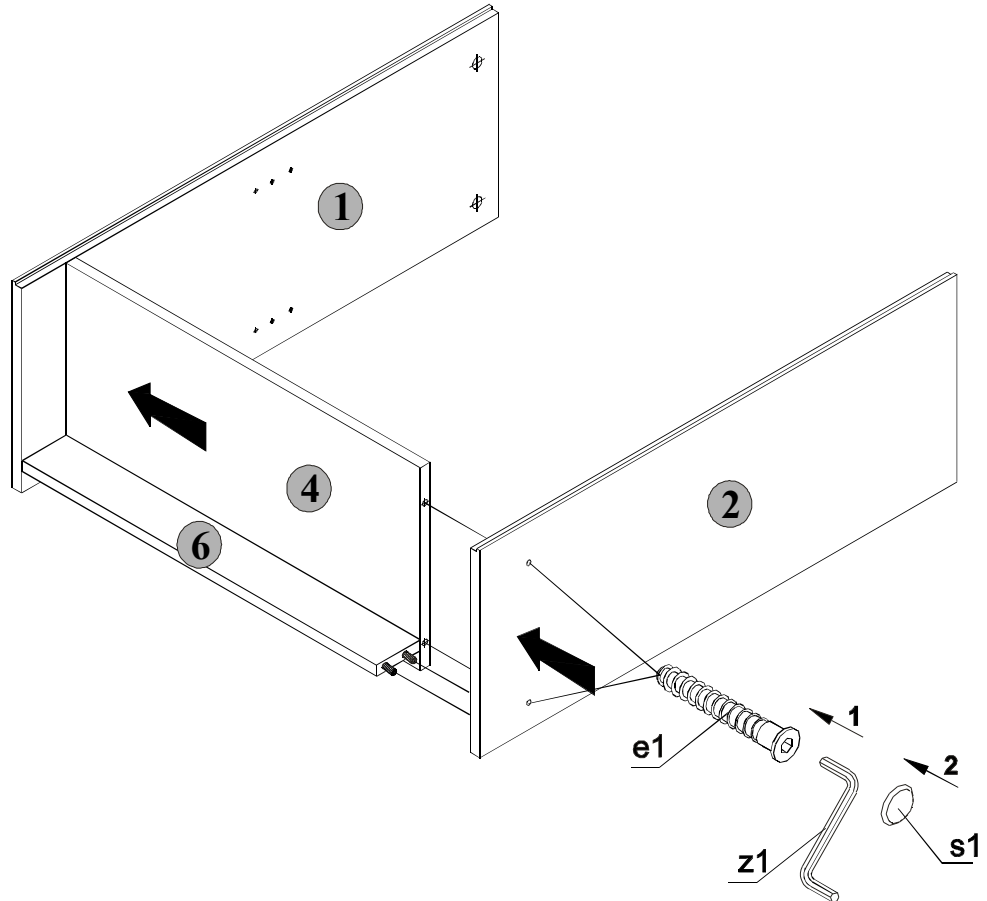

3

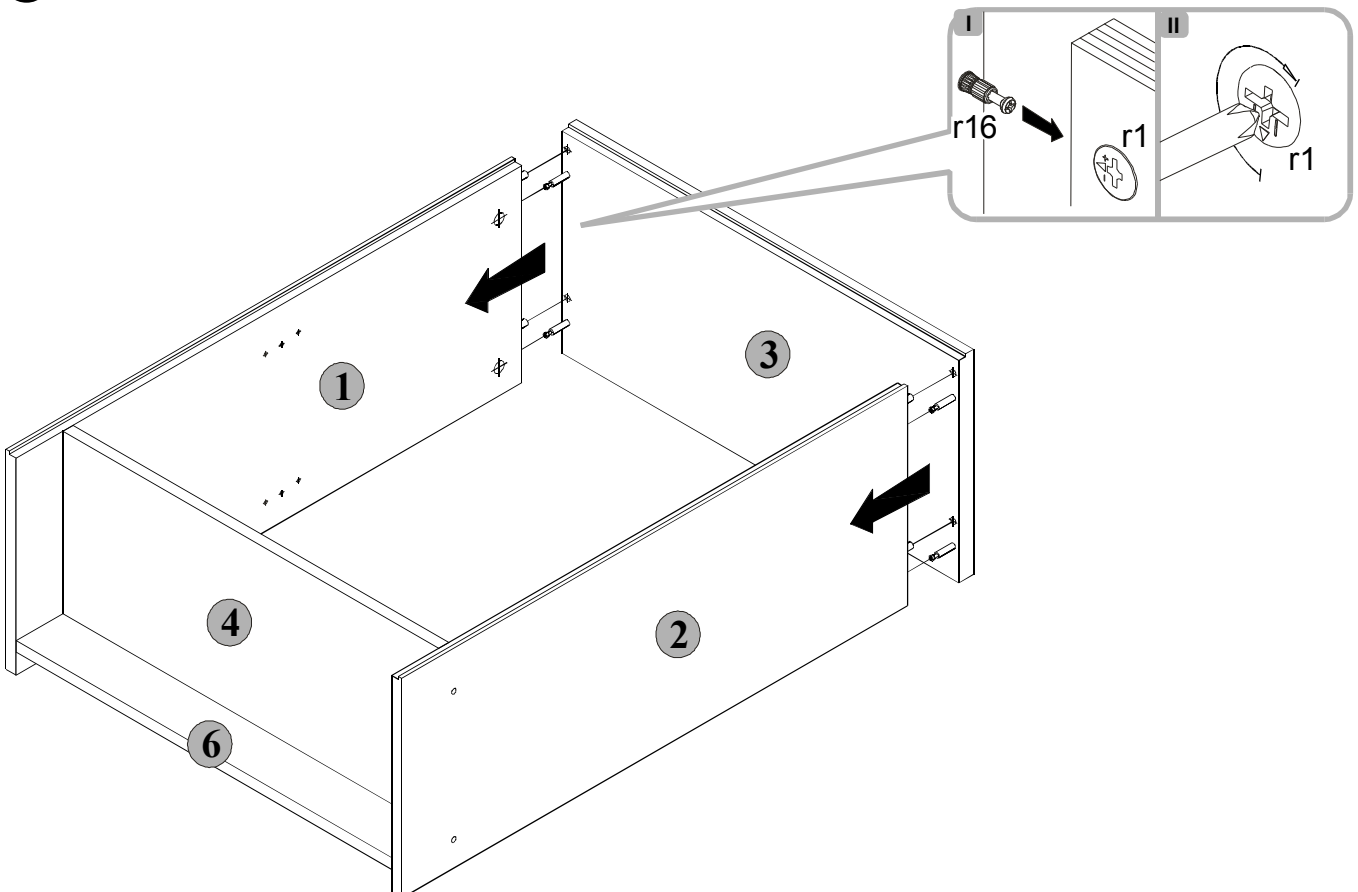

4

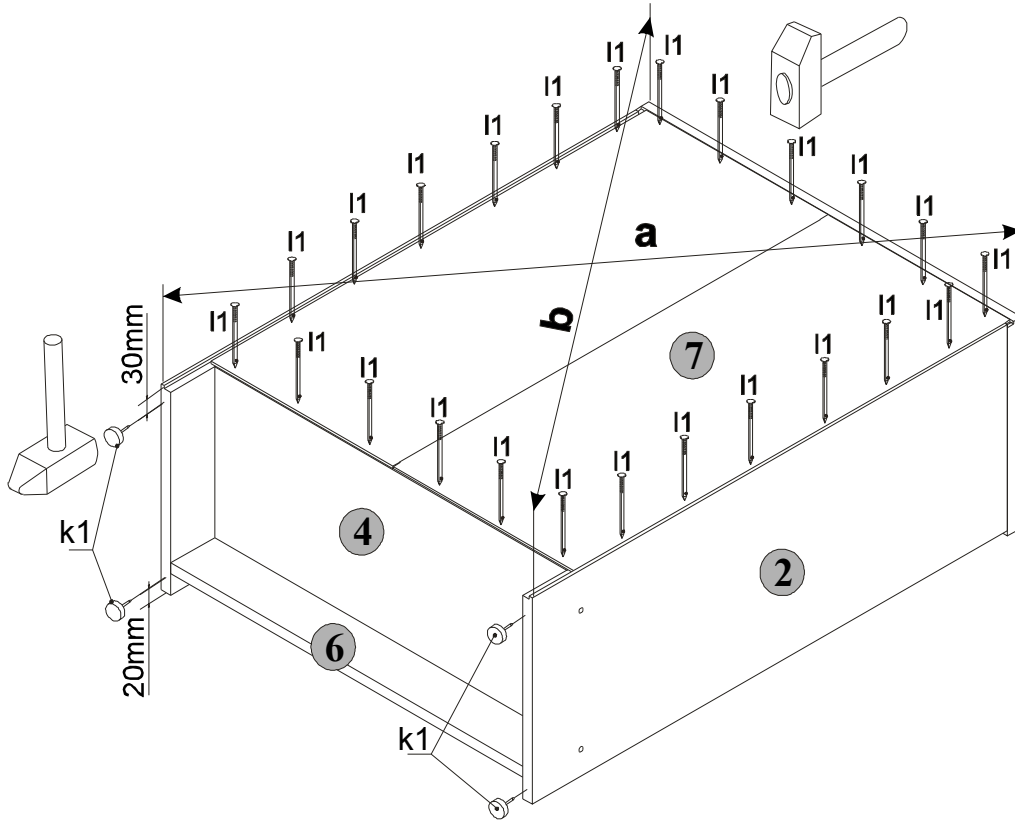
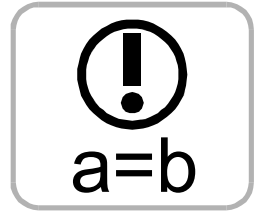

5

