

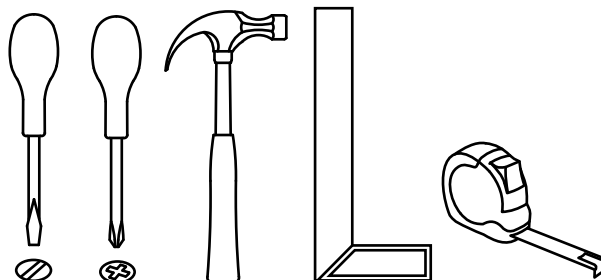

Ferramentas necessárias para montar o móvel.
Herramientas necesarias para armar el mueble.

Tools needed to assemble the furniture.



A montagem deve ser efetuada
por duas pessoas.

**El montaje debe ser efectuado
por dos personas.**

*The assembly must be done
by two people.*

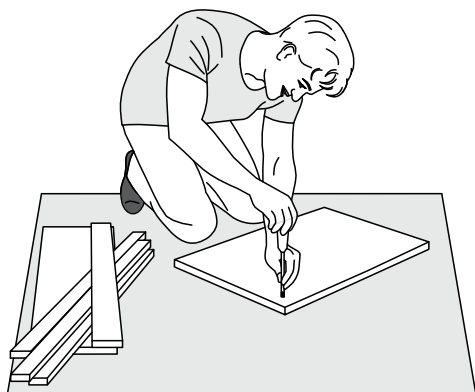
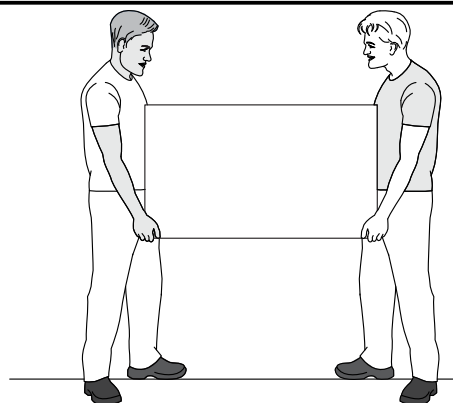

Montar o móvel sobre uma superfície
limpa e plana.

**Armar el mueble sobre una superficie
limpia y plana.**

*Assemble the furniture on a clean and
flat surface.*

Dúvidas? Entrar em contato:

¿Dudas? Ponerse en contacto:

Doubts? Get in touch:

**+351 963 683 631
info@streightex.com
www.streightex.com**



TAMANHO REAL - TAMAÑO VERDADERO - REAL SIZE

Em caso de dúvida, compare as ferragens com as imagens abaixo em tamanho real.

En caso de dudas, compare las herrajes con las imágenes a seguir en tamaño real.

In case of doubt, compare the hardware with the full-size images below.

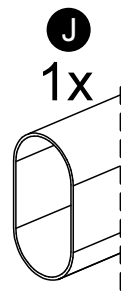
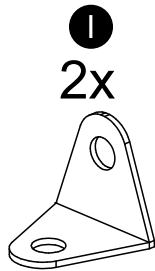
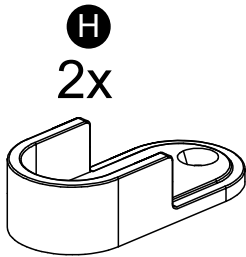
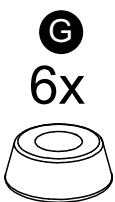
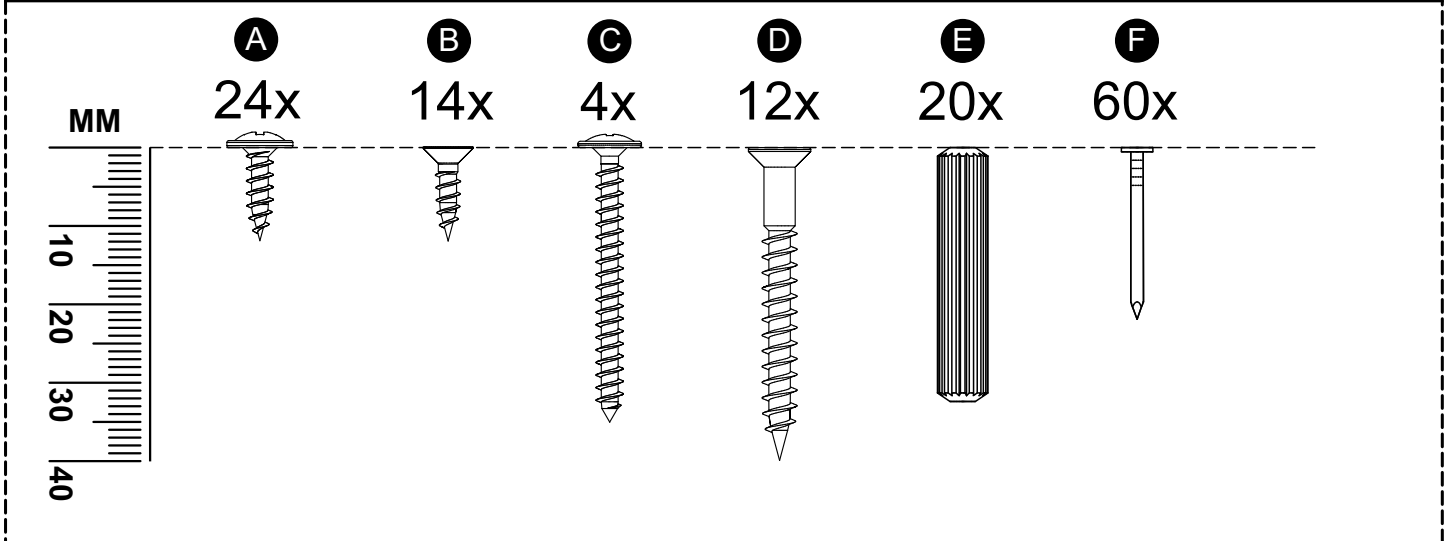
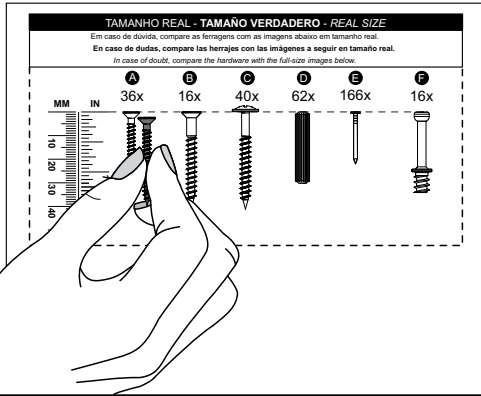

769mm
 30.28in

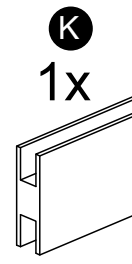

1700mm
 66.93in

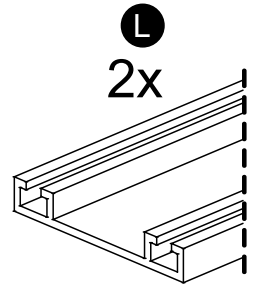

775mm
 30.51in

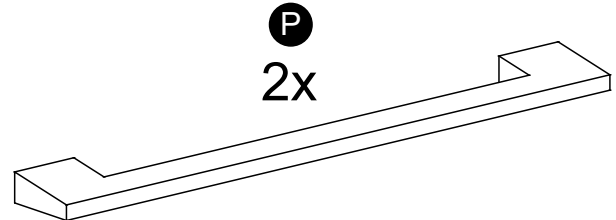
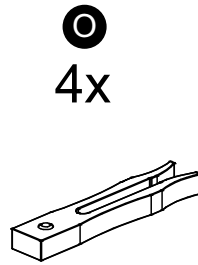
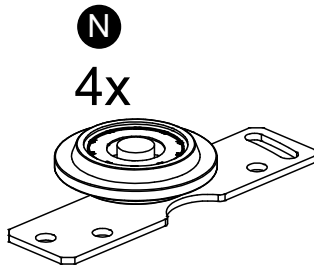
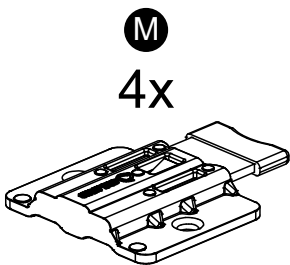



1 (12 x 500 x 1800mm)
(0,47 x 19,69 x 70,87in)

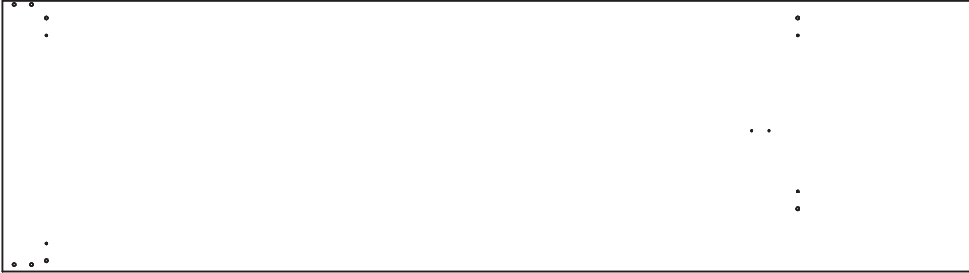

2 (12 x 500 x 1800mm)
(0,47 x 19,69 x 70,87in)

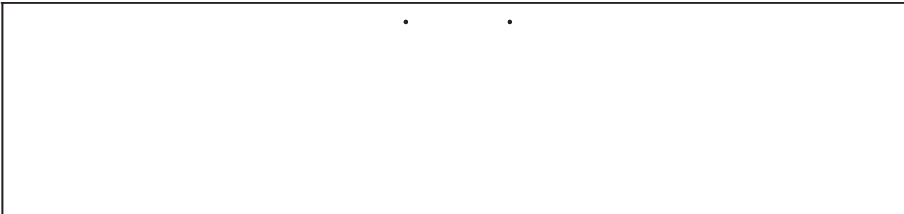

3 (15 x 393 x 1681mm)
(0,59 x 15,47 x 66,18in)

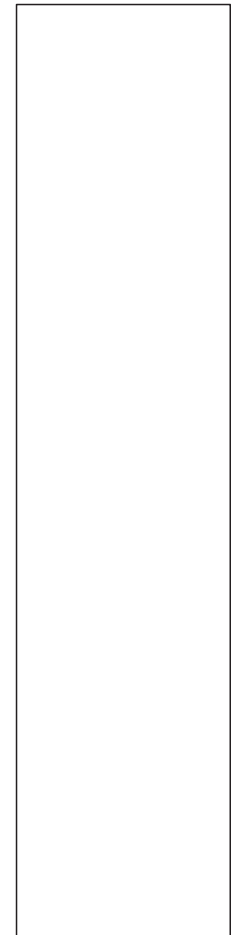

4 (3 x 394 x 1721mm) - 2x
(0,12 x 15,51 x 67,76in)

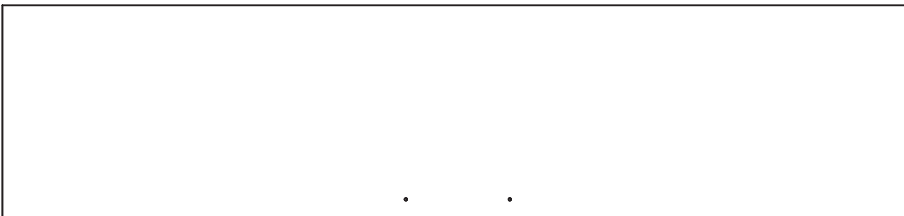

5 (15 x 393 x 1681mm)
(0,59 x 15,47 x 66,18in)



6 (12 x 498 x 776mm)
(0,47 x 19,61 x 30,55in)

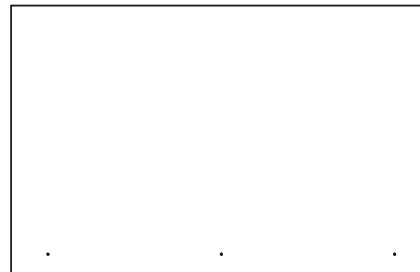

7 (12 x 498 x 776mm)
(0,47 x 19,61 x 30,55in)



8 (12 x 400 x 776mm)
(0,47 x 15,75 x 30,55in)



9 (12 x 75 x 776mm)
(0,47 x 2,95 x 30,55in)



10 (12 x 75 x 776mm)
(0,47 x 2,95 x 30,55in)

1

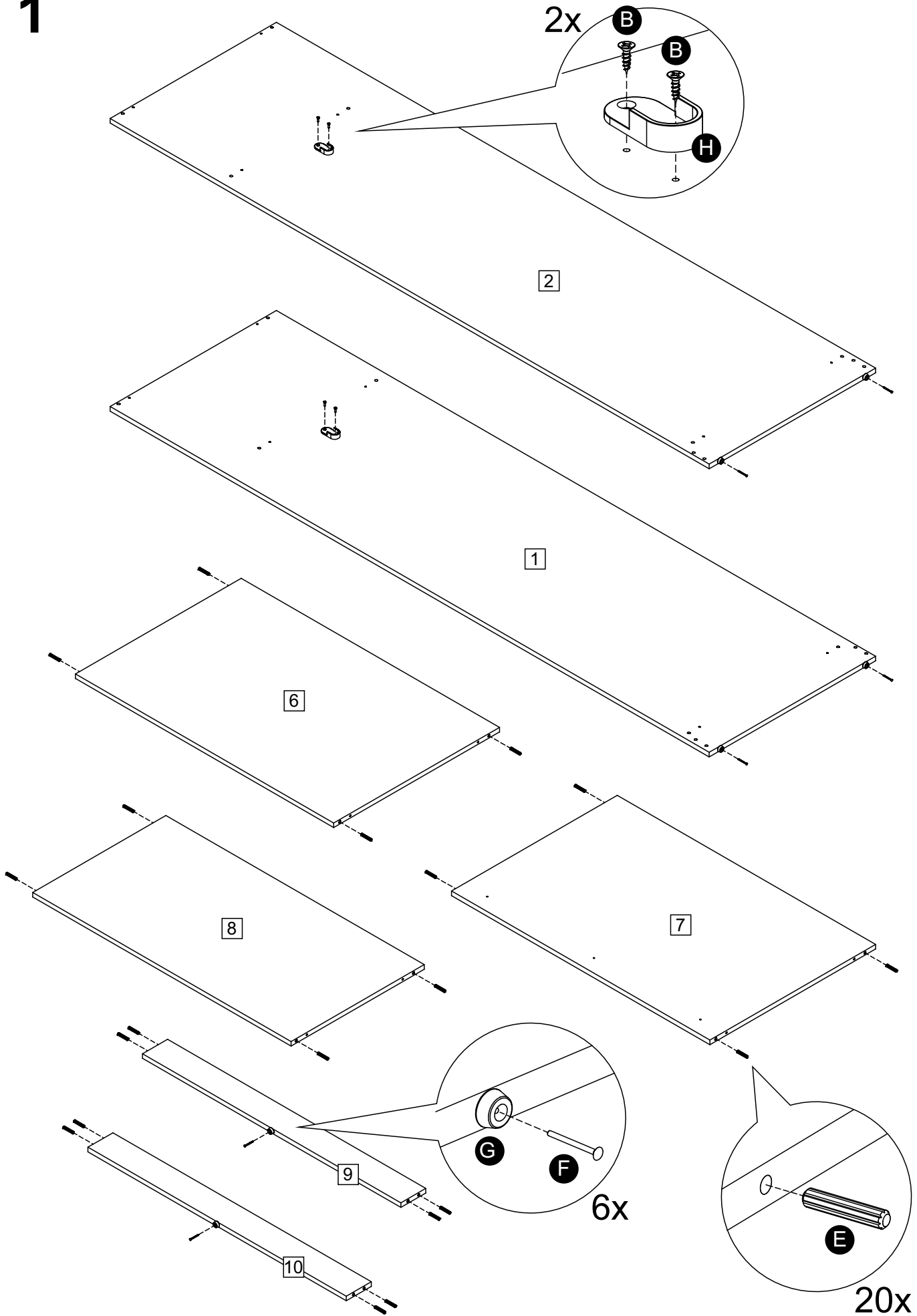

2

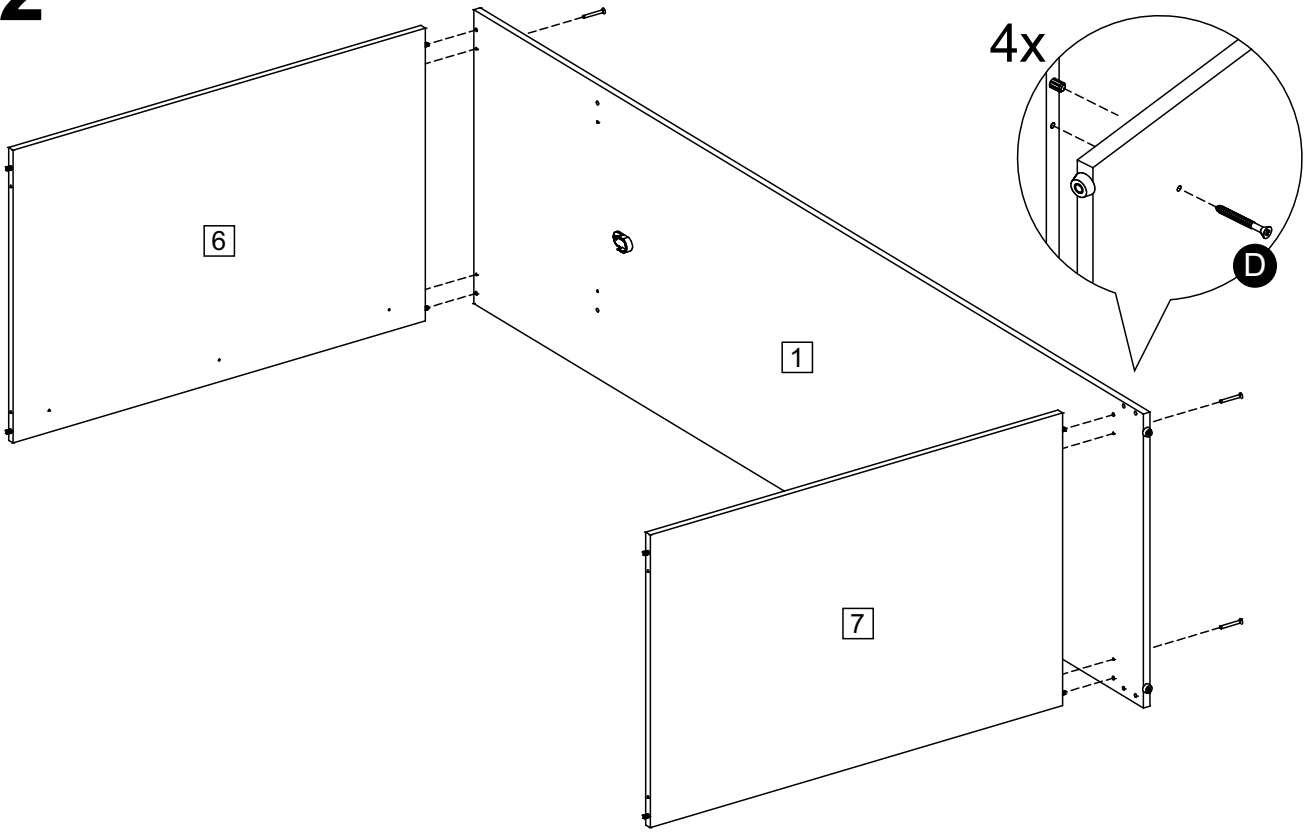

3

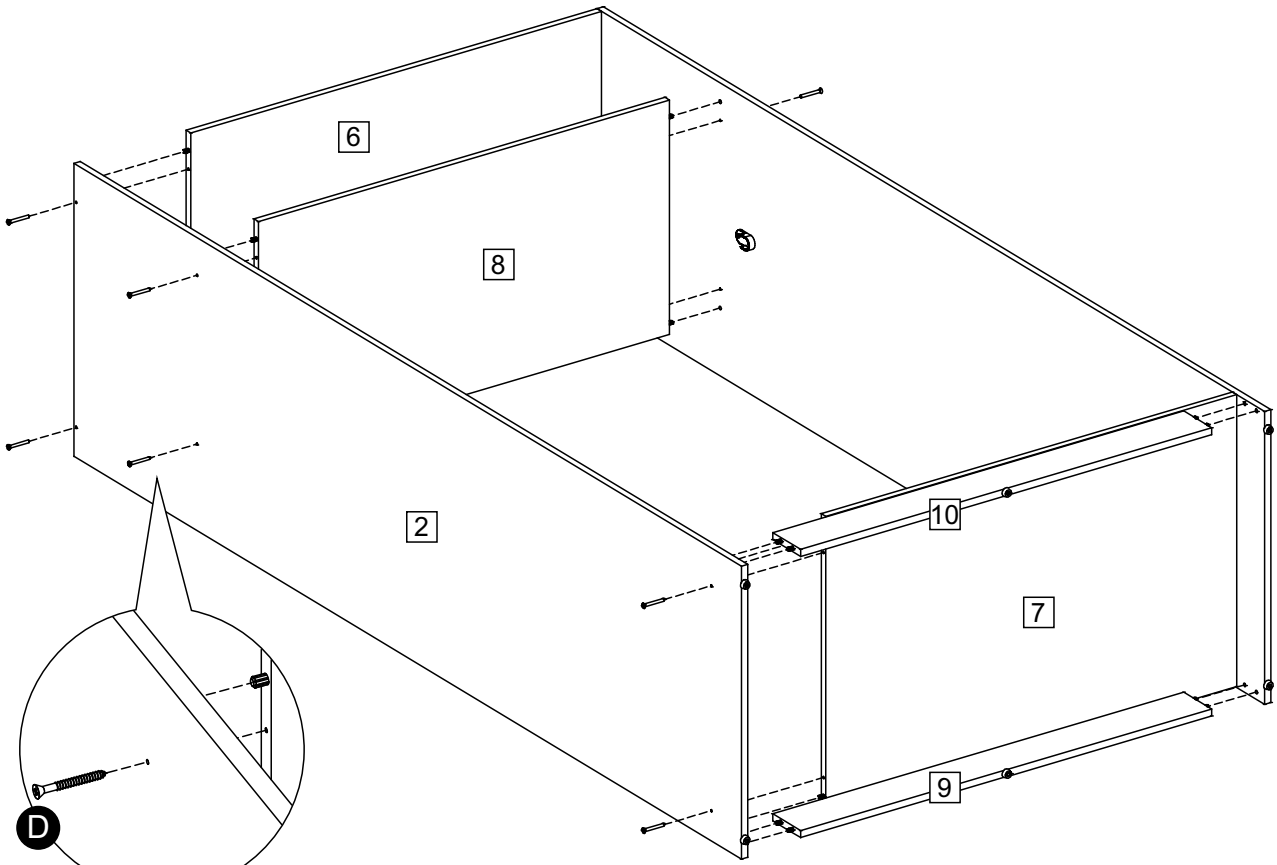

4

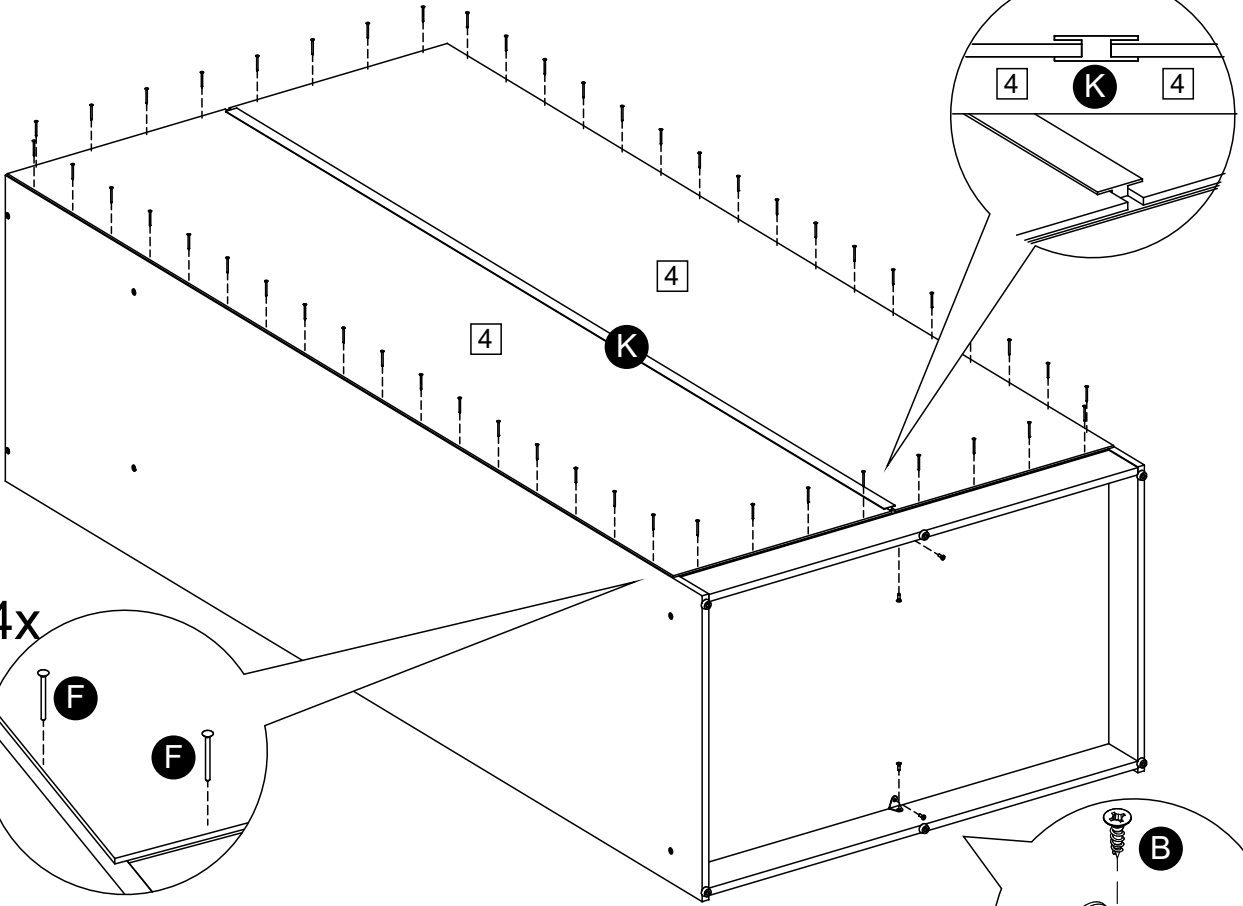

54x

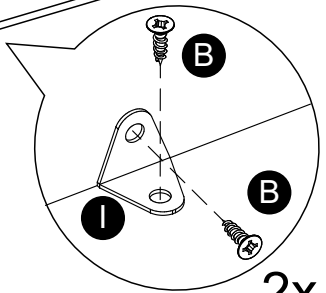
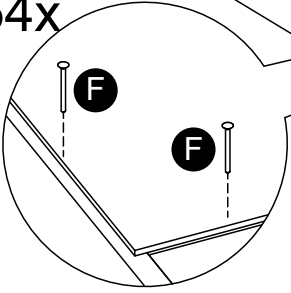

2x

5

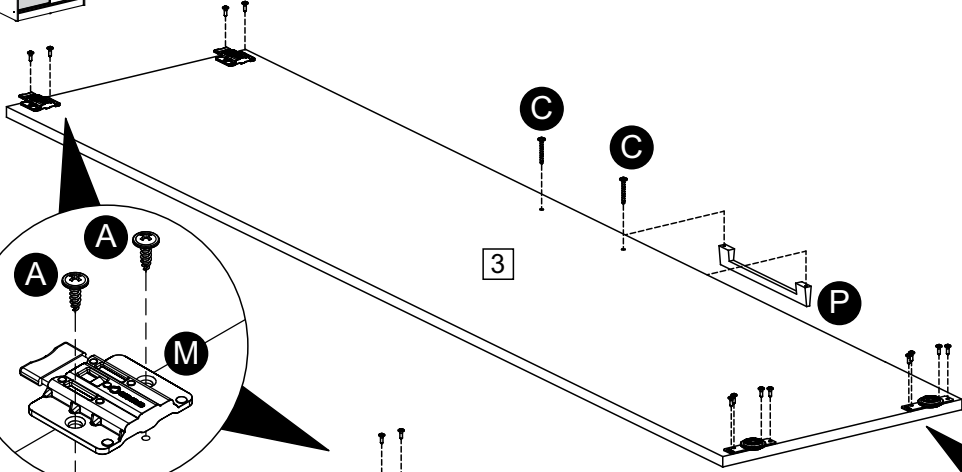
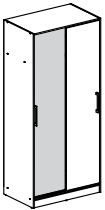

4x

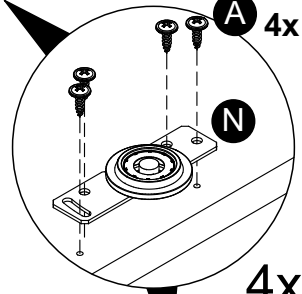
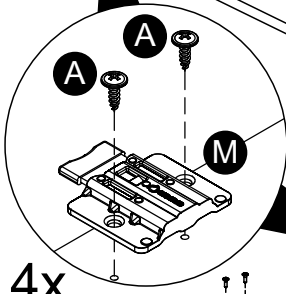

4x

6

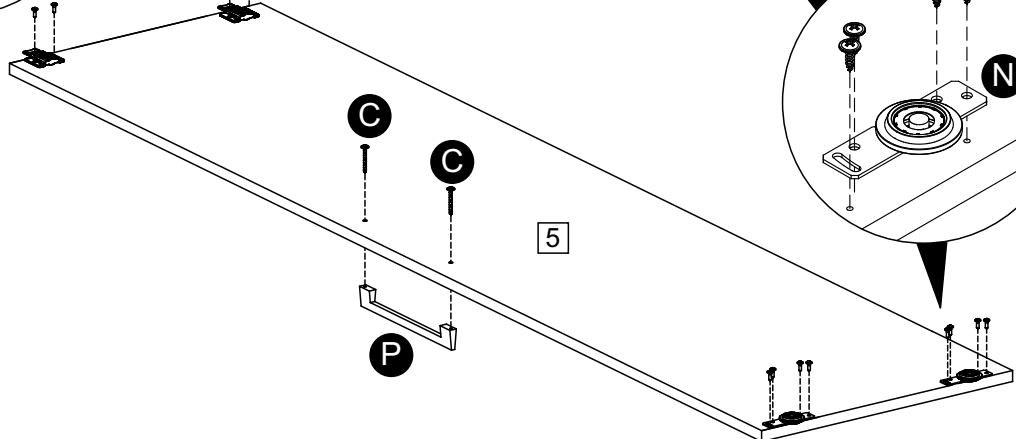
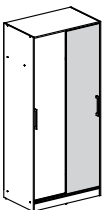

7-2x

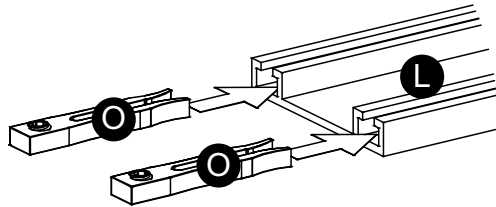

x = 25mm
y = 70mm

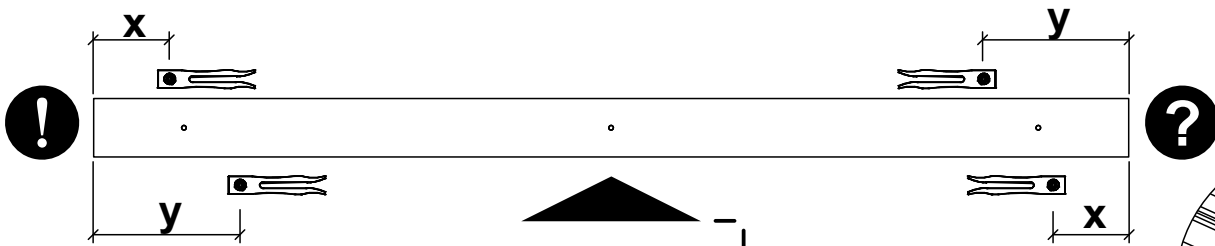

8

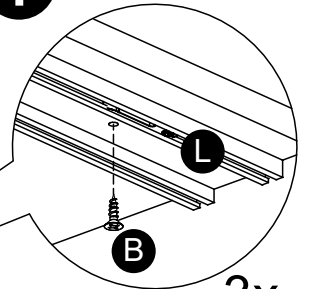
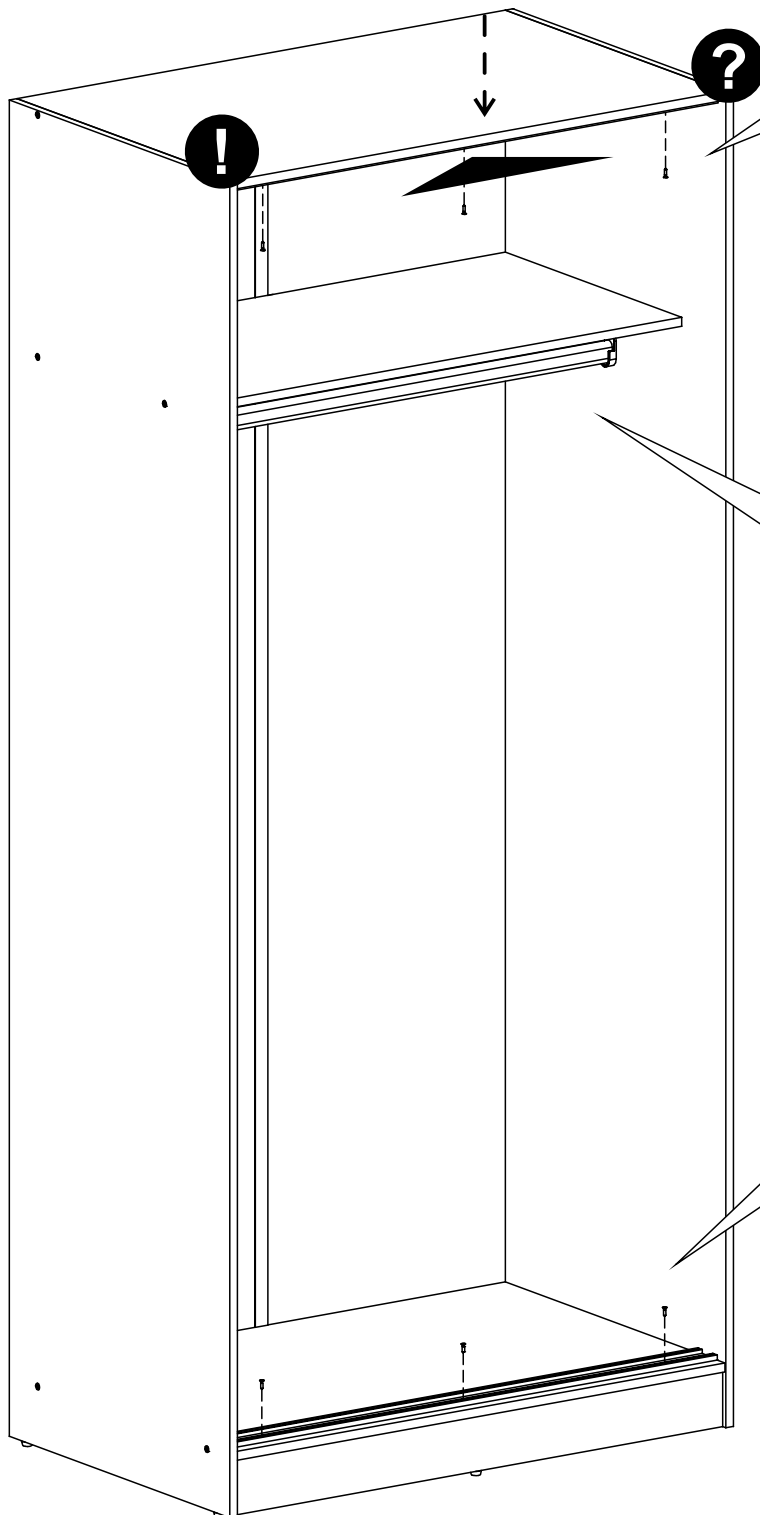

3x

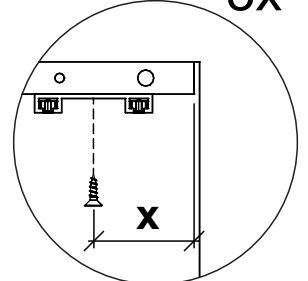

x = 37mm

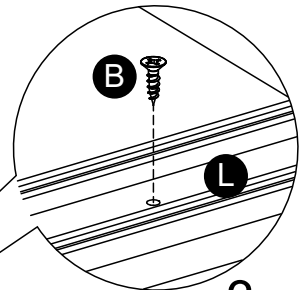
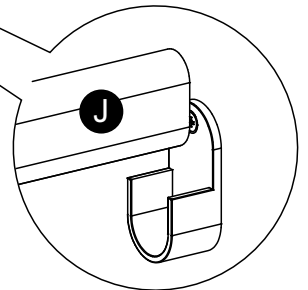

3x

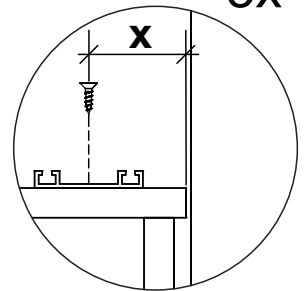

x = 39mm

9

12x

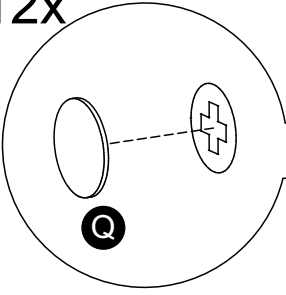

2x

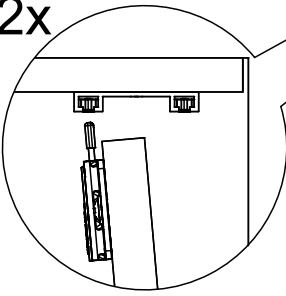

2x

